

Owner's Manual

Einstein™

Remote Education Collar

ET-500 / ET-502

Welcome to **Einstein**

Einstein

Thank you for purchasing the Einstein Remote Education Collar from E-Collar Technologies, Inc. We have made every attempt to provide you with the most technologically advanced product using the most stringent quality and manufacturing standards.

We are confident you will be pleased with the results you will attain with the ET-500 / ET-502.

Please remember you will get better results with the use of lower stimulation combined with consistent training techniques. The use of high levels of stimulation should only be used as a last resort and in life-threatening situations.

Good luck with your training and please feel free to contact us should you have any questions.

1-855-326-5527 or 1-855-ecollar

02

CHARACTERISTICS

- Range : Up to 800 yards
- Momentary and Continuous Stimulation Buttons
- Warning Tone Button
- Employs Ni-MH Rechargeable Batteries
- Convenient Intensity Dial for Quick Adjustment
- Stimulation Levels Adjustable from 0 to 100
- Collar Receiver Light for Night Tracking
- Lock and Set Stimulation Feature

CONTENTS

- Transmitter



- Collar Receiver

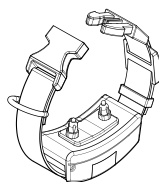

(2 Receiver
for ET-502)

- Battery Charger
(For ET-500 Only)

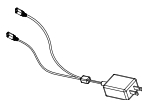

- Battery Charger and Splitter Cable
(For ET-502 Only)



- Lanyard

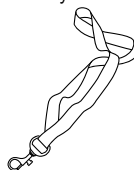

- Owner's Manual

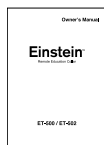

- Test Light

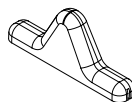

- Contact Points 3/4"



- Contact Point Tool



TABLE OF CONTENTS

• Safety and General Information	05
• Getting Started	06
• Charging the Batteries	08
• Turning Your Einstein On/Off	10
• The LCD Display Features	11
• Button Functions	12
• Changing the Intensity Level of Stimulation	15
• Lock/Unlock the Stimulation Intensity Level	18
• Indicator Light	19
• Testing Your Einstein	20
• Replacing the Contact Points	21
• Correctly Fitting the Collar	22
• Warranty	23
• Contact Information	24

SAFETY AND GENERAL INFORMATION

- The Einstein Education Collar complies with all National and International Standards and Guidelines for human exposure to radio frequency electromagnetic energy.
- Nearly all electronic devices are susceptible to electromagnetic interference (EMI) if inadequately shielded or designed without precautions to EMI.
- Einstein E-Collar transmitters manufactured by E-Collar Technologies, Inc. comply with Article 15 of the FCC rules and operate under Part 95 of FCC regulations.
- **IMPORTANT NOTICE**
 1. To avoid Electromagnetic Interference and/or compatibility conflicts, please turn off your transmitter and collar receiver in any facility where posted notices instruct you to do so. Never use your equipment in close proximity of a Hospital or Health Care Facility or enter the facility without turning off both units.
 2. An FCC license is not needed to operate Einstein E-Collar transmitters. However, any change or modification made to the transmitter, including the supplied antenna, without the expressed written approval of E-Collar Technologies, Inc. could void your authority to operate.

06

TRANSMITTER PARTS

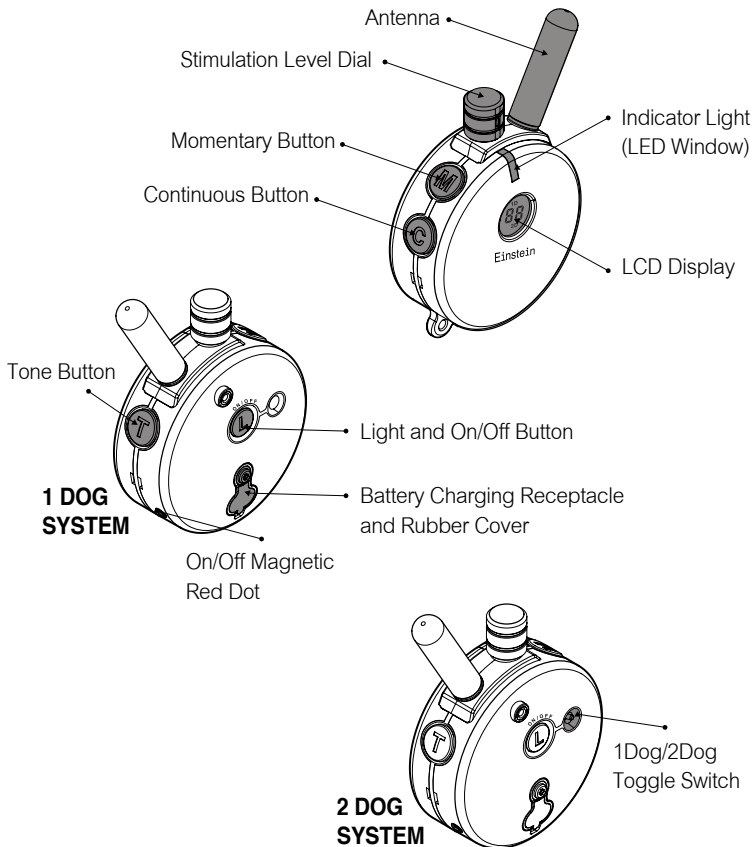

COLLAR RECEIVER PARTS

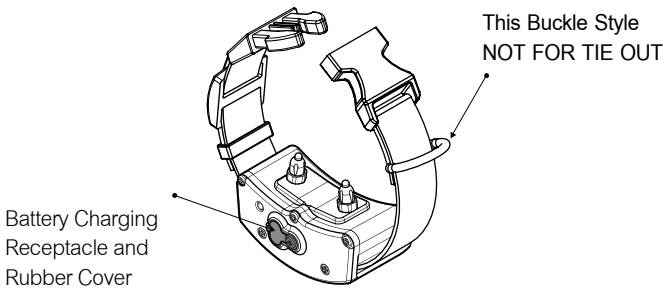
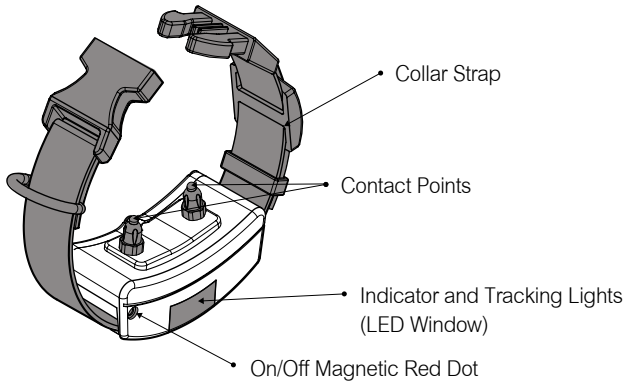

CHARGING THE BATTERIES

Indicator Light will blink “Green” under normal operation. It will flicker “Red” when stimulation is applied and will blink “Red” when recharging is required. We recommend you fully charge your Einstein every six months when not in use to maintain battery life.

Battery Charger (For ET-500 Only)

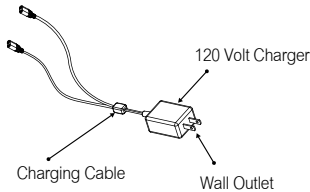

Battery Charger and Splitter Cable (For ET-502 Only)

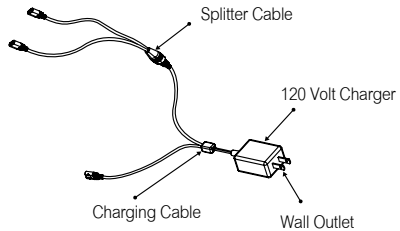

Transmitter Battery Charging Receptacle and Rubber Cover

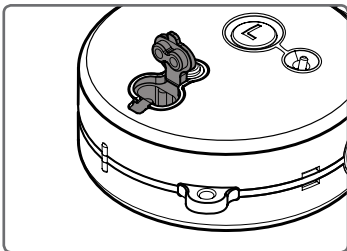

Collar Receiver Battery Charging Receptacle and Rubber Cover

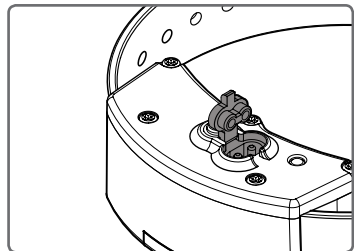

- The indicator light will turn solid red during the 10 to 12 hour charge cycle and stay red even though the unit is fully charged.

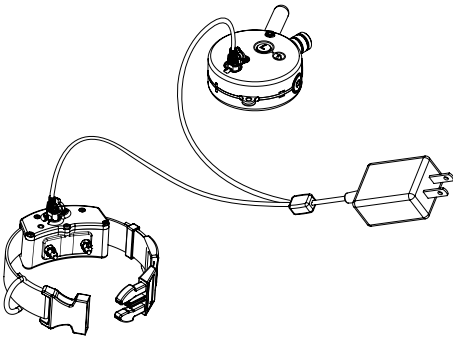
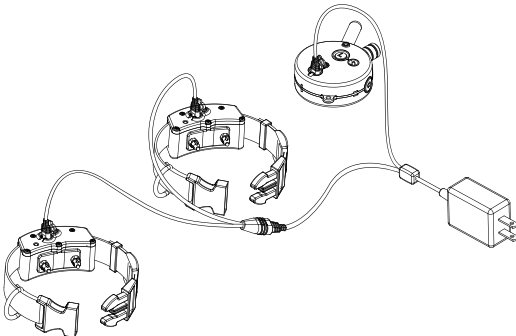
ET-500**ET-502**

10

TURNING YOUR Einstein ON/OFF

COLLAR RECEIVER ON/OFF MAGNETIC SWITCH

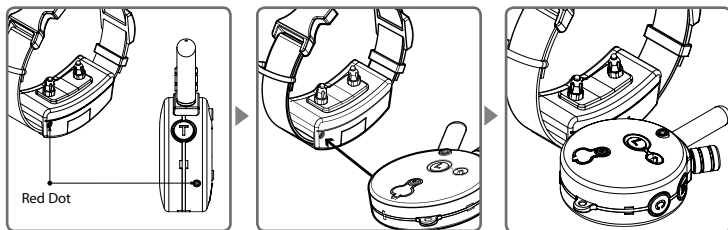

- To turn the Collar Receiver On or Off :

Position the red dot on the Transmitter close to the red dot on the Collar Receiver. Two beeps will confirm the collar receiver has been turned on and a single beep will confirm the unit has been turned off. Push the tone button to assure the unit is on and properly functioning.

TRANSMITTER ON/OFF BUTTON

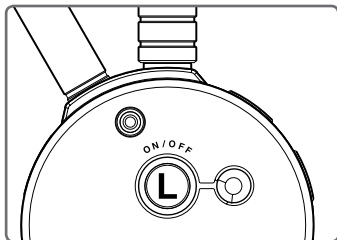

- To turn the Transmitter On or Off :
Press the "L" light button for more than 2 seconds.
If "L" light button is pressed less than 0.5seconds, it will turn On/Off Tracking lights of Collar Receiver.

THE LCD DISPLAY FEATURES

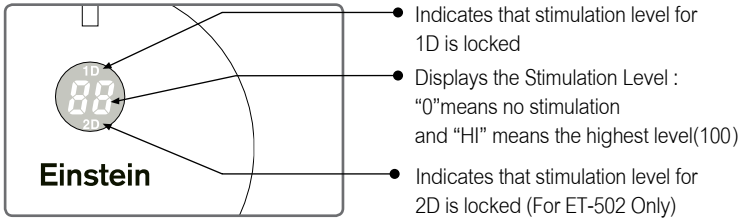

- Press down on the Stimulation Level Knob or press any button to wake up the LCD display. Please note that if the collar receiver is on, pressing the stimulation buttons and/or the tone button will trigger the collar receiver.

12

BUTTON FUNCTIONS(ET-500)

TRANSMITTER(1 DOG SYSTEM)

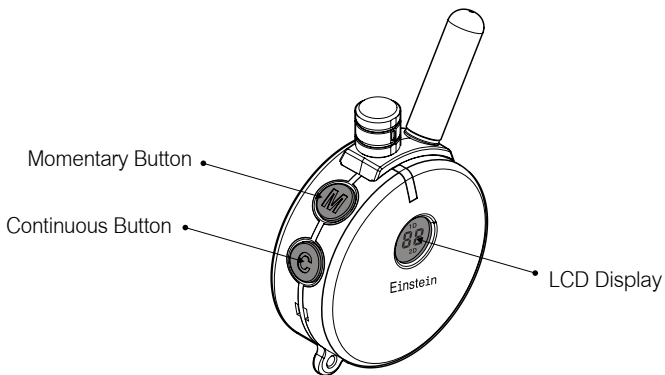
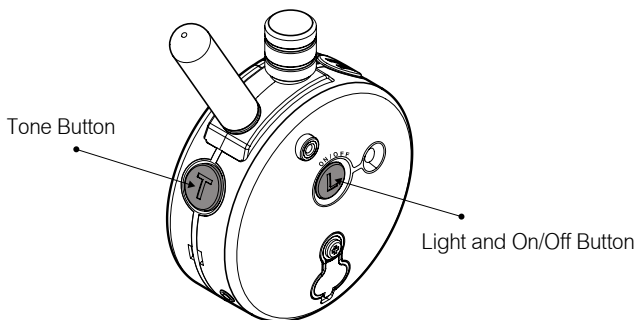

The ET-500 transmitter is equipped with four control buttons, LCD display, and an adjustable dial. For long range use hold the transmitter up like the Statue of Liberty and never allow the antenna to touch anything as it will decrease the range. Power lines and foliage will also reduce the range.

Momentary Button “M”

- Sends a short pulse of stimulation to the collar receiver.

Continuous Button “C”

- Sends stimulation to the collar receiver for the duration of the button being pressed.
- After 10 seconds the Over-Stimulation feature will stop the stimulation until the button is released and pressed again.

Tone Button “T”

- Sends warning tone to the collar receiver.

Light Button “L”

- When pressed less than 0.5 seconds, it will turn On or Off the high intensity night tracking light which is good for finding your dog after dark.
- When pressed for more than 2 seconds, it will turn On or Off the transmitter.

14

BUTTON FUNCTIONS(ET-502)

TRANSMITTER(2 DOG SYSTEM)

Toggle switch on the backside of the transmitter allows the user to switch between Dog 1 and Dog 2.

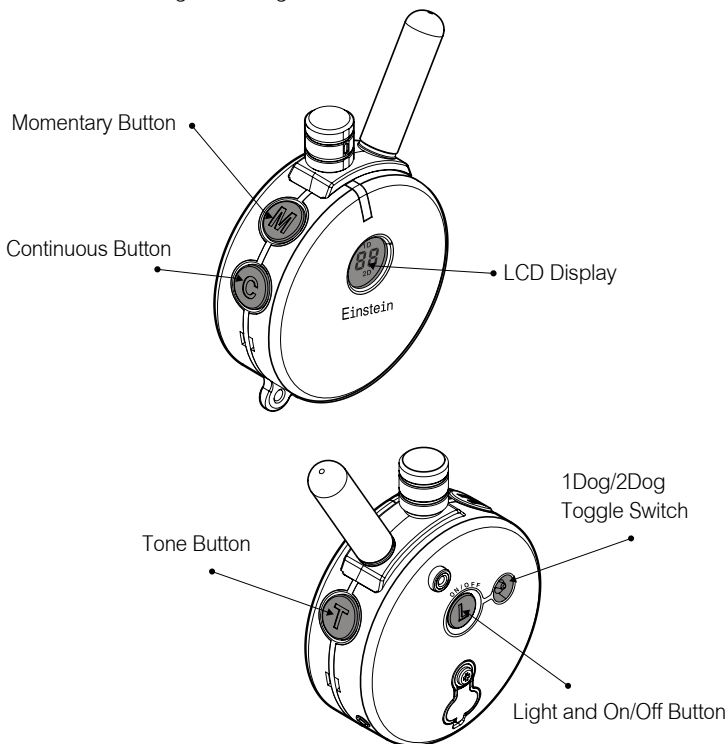

CHANGING THE INTENSITY LEVEL OF STIMULATION

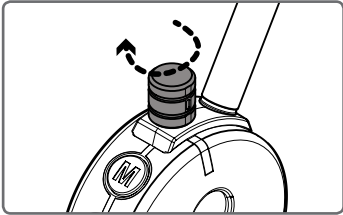

Rotating clockwise increases the stimulation level and conversely, rotating counter-clockwise lowers the stimulation level.

It is highly recommended that the user practices changing levels and modes before putting the collar receiver on the dog.

Setting the correct stimulation level for your dog is very important. To set your “conditioning” stimulation level, put the collar receiver (see page 22 for proper fitting technique) on your dog. Let him/her get used to the collar receiver for a couple of hours. While watching your dog, turn the level to “0” and press the continuous button.

Slowly turn the stimulation up at a rate of approximately 2-3 levels per second. When your dog first perceives the stimulation, usually between 15 and 40, release the button. This is your “conditioning” stimulation level. You may need to add a few levels later as your dog becomes more conditioned to the stimulation. The “conditioning” stimulation is used when the trainer wants to use the stimulation in continuous mode.

16

CHANGING THE INTENSITY LEVEL OF STIMULATION

For example, if you want your dog to come to you and heel, you can hold the button down until your dog comes and heels or if jumping is an issue, you can hold the button down anytime their front paws are off the ground.

Setting the “Corrective” stimulation level is a little more difficult due to the wide differences in temperaments and stimulation tolerance among the many breeds of dogs. On average, it is normally 20 to 40 levels higher than the “Conditioning” level. This higher level will only be used in “Momentary” mode as not to over-stimulate your dog. This mode is used for stopping unwanted behaviors such as chewing, digging, street-running, excessive barking, and aggressiveness, etc. It is important to apply the “Momentary” stimulus at the exact time of the unwanted behavior. Additional pulses may be used to reinforce the command if compliance is not immediate.

CHANGING THE INTENSITY LEVEL OF STIMULATION

IMPORTANT TRAINING TIP

E-Collars should be used to reinforce commands your dog already knows. It is not a replacement for basic leash obedience training, but a tool to allow you to better communicate to your dog.

For best results, use the least amount of stimulation required to get compliance from your dog. A calm and consistent approach to training will always produce better long term results. It is highly recommended that aggressive dogs be taken to a professional trainer for evaluation before e-collar use.

A variety of E-Collar training videos are available on YouTube by searching “e-collar training” and “that’s my dog”.

Happy Training.

18

LOCK/UNLOCK THE STIMULATION INTENSITY LEVEL

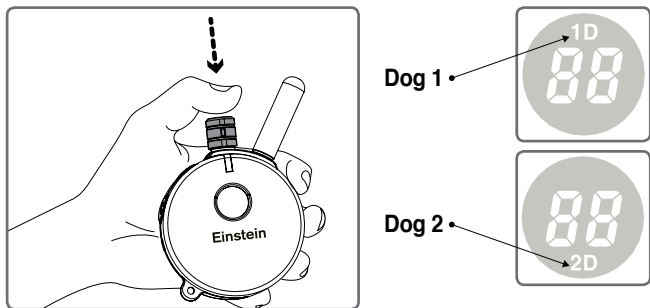

How to Lock/Unlock the Stimulation Level

This feature is useful when controlling two dogs (ET-502) simultaneously and you want to have different stimulation levels for each dog.

With the toggle switch in “1-D” position, set the desired stimulation level and then push down on the top of the stimulation dial until you see “1D” light up on the top portion of the LCD display. If the stimulation level doesn’t change when you rotate the stimulation knob, you have successfully locked the stimulation level of Dog 1.

Flip the toggle switch to the “2-D” position and repeat the previous step. The “2D” light on the bottom portion of the LCD display will light up when you have successfully locked the stimulation level on Dog 2.

To unlock the stimulation level simply press the stimulation knob again and it will unlock the stimulation level of the dog specified by the toggle switch.

INDICATOR LIGHT

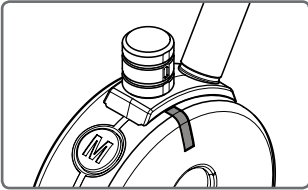

- **TRANSMITTER INDICATOR LIGHT**

Battery Charge level is signified by the light going from “green” (ready for use) to “amber” (need to charge soon) and then to “red” (charge immediately). When any of the function buttons are pressed the indicator light will turn “red” to signify activation.

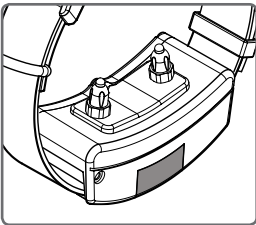

- **COLLAR RECEIVER INDICATOR LIGHT**

Battery Charge level is signified by the light going from “green” (ready for use) to “amber” (need to charge soon) and then to “red” (charge immediately). When any of the function buttons of the transmitter are pressed, the indicator light on the collar receiver will flicker “red” indicating a control signal has been successfully received.

20

TESTING YOUR Einstein

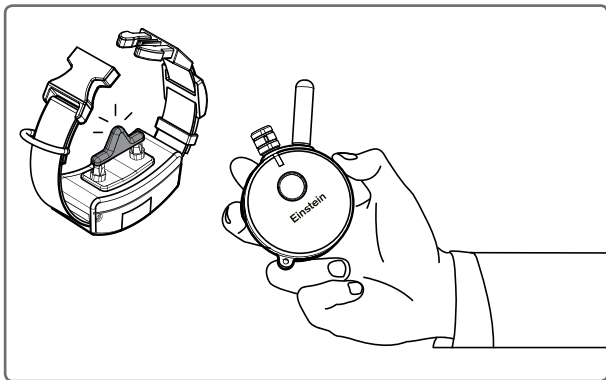

Snap the test light onto the contact points as shown in the above figure. With both units on and green lights flashing, press the continuous stimulation button while turning the stimulation up and down, the test light should brighten as you go higher in stimulation. The collar receiver light will flicker red while the stimulation is on. Next, push the tone button to test the tone feature. Your Einstein E-Collar is ready to use.

REPLACING THE CONTACT POINT

The standard 5/8" contact points are used for most dogs. Thicker fur breeds require the longer 3/4" contact points. Replace the 5/8" contact points by following the instructions below using the enclosed contact point tool.

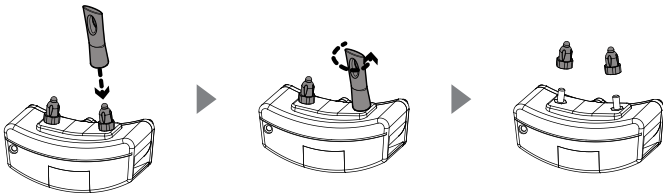

1. Loosen both contact points by rotating the contact point counter-clockwise using the contact point tool.

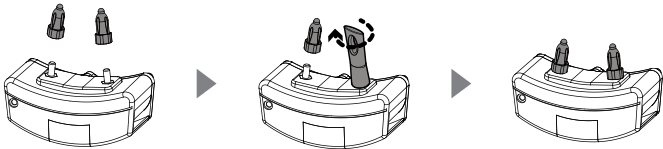

2. Install the 3/4" contact points onto the bolt and tighten the contact points by rotating them clockwise with the contact point tool.

CORRECTLY FITTING THE COLLAR

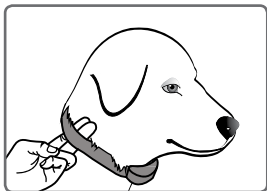

The collar should be adjusted to allow the “contact points” to have direct contact with the skin. You should be able to fit a couple of fingers between the collar strap and your dog.

Too tight poses the risk of skin irritation and discomfort. Too loose and the contact points will not be able to administer the stimulation reliably. The optimal position for the collar receiver is on either side of the dog's windpipe.

IMPORTANT NOTICE

To prevent the occurrence of skin irritations the Collar Receiver should never be worn for more than 12 hours per day. Should your dog experience skin irritations from over exposure to the contact points remove the collar receiver unit immediately and stop using your e-collar until all skin irritations are totally healed. Antibiotic ointment will aid in the healing process. Some dog breeds have very thick fur that requires special contact points, please contact our customer service or visit www.ecollar.com for more information.

WARRANTY

To Register for the Limited Lifetime Warranty :

To register your Einstein product, please log onto our website at www.ecollar.com, click on the warranty registration link and fill out the required information. Please register your product within 30 days of your purchase. If you do not have access to a computer, please call our toll free number of 1-855-326-5527 and one of our customer service representatives will register your product for you. In the event the product is not properly registered proof of purchase will be needed to obtain warranty work. Product returns without proper registration and proof of purchase will be subject to a warranty start date estimated by your units serial number. Misuse, improper maintenance, lost units are not covered by this warranty.

Limited Lifetime Warranty :

Your Limited Lifetime Warranty begins the date of the original purchase. For the first two years both parts and labor are covered 100%. The rechargeable batteries have a one year replacement warranty. After the two year replacement warranty has expired the Limited Lifetime Warranty will cover the material to repair your e-collar system not including the accessories and antennas. The labor and shipping costs are not included and are the responsibility of the customer. Labor fees will be calculated based on the extent of the work performed. The Limited Lifetime Warranty will expire 5 years from the date the model is discontinued by E-Collar Technologies, Inc. Any attempt by the user to repair or open the e-collar including battery replacement will void the warranty.

CONTACT INFORMATION



E-Collar Technologies, Inc.
2120 Forrest Park Drive
Garrett, IN 46738
Toll-Free 1-855-326-5527
Toll-Free Fax 1-855-226-5527
www.ecollar.com
sales@ecollar.com
customerservice@ecollar.com



E-Collar Technologies, Inc.

2120 Forrest Park Drive
Garrett, IN 46738-1887

1-855-326-5527 (Toll Free)

• Ext. 1: Sales • Ext. 2: Customer Service

1-855-226-5527 (Toll Free Fax)

customerservice@ecollar.com

www.ecollar.com

Patents Pending

©2011 E-Collar Technologies, Inc.



Thank you for Supporting American Workers