

yardmax™

rechargeable in-ground fence™

operating and training guide

Model Number
PIG00-11115



protect. teach. love.™

PLEASE READ THIS ENTIRE GUIDE BEFORE BEGINNING

Thank you for choosing PetSafe®, the best selling brand of electronic training solutions in the world. Our mission is to be the most trusted brand in the pet ownership experience. We want to ensure your pet's safety by providing you with the tools and techniques to successfully train your pet. If you have any questions, please contact the Customer Care Center at 1-800-732-2677 or visit our website at www.petsafe.net.

To get the most protection out of your warranty, please register your product within 30 days at www.petsafe.net. By registering and keeping your receipt, you will enjoy the product's full warranty and should you ever need to call the Customer Care Center, we will be able to help you faster. Most importantly, PetSafe® will never give or sell your valuable information to anyone. Complete warranty information is available online at www.petsafe.net.

Important Safety Information

Explanation of Attention Words and Symbols used in this guide



This is the safety alert symbol. It is used to alert you to potential personal injury hazards. Obey all safety messages that follow this symbol to avoid possible injury or death.

⚠ WARNING

WARNING indicates a hazardous situation which, if not avoided, could result in death or serious injury.

⚠ CAUTION

CAUTION, used with the safety alert symbol, indicates a hazardous situation which, if not avoided, could result in minor or moderate injury.

CAUTION

CAUTION, used without the safety alert symbol, indicates a hazardous situation which, if not avoided, could result in harm to your pet.

NOTICE

NOTICE is used to address safe use practices not related to personal injury.

⚠ WARNING

- Not for use with aggressive dogs. Do not use this product if your dog is prone to aggressive behavior. Aggressive dogs can cause severe injury or death to their owners and others. If you are not sure that this product is right for your dog, please talk to your veterinarian or a certified trainer.
- Underground cables can carry high voltage. Have all underground cables marked before you dig to bury your wire. In most areas this is a free service. Avoid these cables when you dig.
- Follow all safety instructions for your power tools. Be sure to always wear your safety goggles.
- Do not install, connect, or remove your system during a lightning storm. If the storm is close enough for you to hear thunder, it is close enough to create hazardous surges.
- Risk of electric shock. Use the Fence Transmitter and Surge Protector indoors in dry location only.
- Turn off power to outlet before you install or remove your Surge Protector.
- Risk of electrical shock or fire. Use Surge Protector only with a duplex outlet with center screw. Attach using long screw supplied.

⚠ CAUTION

- Risk of injury. Wire on top of the ground may be a trip hazard; Use care in how you place your wires.
- Do not install the Surge Protector if there is not at least 30 feet (10 meters) or more of wire between the electrical outlet and electrical service panel.

CAUTION

This PetSafe® In-Ground Fence™ is not a solid barrier. This system is designed to act as a deterrent to remind dogs by Static Correction to remain in the boundary established. It is important that you reinforce training with your dog on a regular basis.

Proper fit of the collar is important. A collar worn for too long or made too tight on the dog's neck may cause skin damage. Ranging from redness to pressure ulcers; this condition is commonly known as bed sores.

- Avoid leaving the collar on the dog for more than 12 hours per day.
- When possible reposition the collar on the dog's neck every 1 to 2 hours.
- Check the fit to prevent excessive pressure; follow the instructions in this manual.
- Never connect a lead to the electronic collar; it will cause excessive pressure on the contacts.
- When using a separate collar for a lead, don't put pressure on the electronic collar.
- Wash the dog's neck area and the contacts of the collar weekly with a damp cloth.
- Examine the contact area daily for signs of a rash or a sore.
- If a rash or sore is found, discontinue use of the collar until the skin has healed.
- If the condition persists beyond 48 hours, see your veterinarian.
- For additional information on bed sores and pressure necrosis, please visit our website.

These steps will help keep your pet safe and comfortable. Millions of dogs are comfortable while they wear stainless steel contacts. Some dogs are sensitive to contact pressure. You may find after some time that your dog is very tolerant of the collar. If so, you may relax some of these precautions. It is important to continue daily checks of the contact area. If redness or sores are found, discontinue use until the skin has fully healed.

You may need to trim the hair in the area of the Contact Points. Never shave the dog's neck; this may lead to a rash or infection.

- The Receiver Collar should not be on your dog when the system is tested. Your dog may receive an unintended correction.
- The Boundary Width of the system must be tested whenever an adjustment is made to the pet area to prevent unintended corrections to your dog.
- Do not change transmitter setting from Traditional mode (B) to YardMax™ mode (A) without verifying that the Receiver Collar will still contain your pet.
- If you use a collar and leash for training, be sure the extra collar does not put pressure on the contact points.
- Always remove your dog's Receiver Collar before performing any Fence Transmitter testing.
- If possible, DO NOT use an AC circuit protected with a Ground Fault Circuit Interrupter (GFCI) or Residual Current Device (RCD). In rare cases, nearby lightning strikes may cause the GFCI or RCD to trip. Without power your dog may be vulnerable to escape. You will have to reset the GFCI or RCD to restore power to the system.

NOTICE

- Plug the Surge Protector into a grounded (3-prong) outlet that is within 5 feet of the Fence Transmitter. ALWAYS use a grounded (3-prong) outlet to ensure maximum protection.
- Do not remove the ground prong from the Surge Protector plug. Do not use a 3-prong plug to 2-prong outlet converter. Doing so will make the Surge Protector ineffective against surges or spikes.
- Use care when mowing or trimming your grass not to cut the loop wire.
- Verify that the boundary loop and transmitter wires connect to the proper Surge Protector terminals. Reversed connections will result in an increased risk of surge related damage.
- For added protection, when unused for long periods of time or prior to thunderstorms, unplug from the wall outlet and disconnect the loop boundary wires. This will prevent damage to the transmitter due to surges.
- Do not charge your Receiver Collar every night. Charging too often can reduce battery life. Charge your Receiver Collar when the Receiver Indicator Light blinks yellow; or when the light blinks red.
- Avoid damage to the jacket of the loop wire during the install; damage may cause areas of weak signal and lead to early failure of the loop (wire breaks).
- To prevent an unintended correction, after the Boundary Flags have been placed, be sure to set the Static Correction on the Receiver Collar back to level 1 tone only.

Table of Contents

Components.....	7
Other Items You May Need.....	7
How the System Works	8
Key Definitions	8
Operating Guide	9
Install the Fence Transmitter	9
Charge the Receiver Collar	9
Prepare the Receiver Collar	10
Lay Out the System	12
Position the Boundary Wire	13
Install the Surge Protector & Connect the Wires.....	15
Verifying Transmitter Boundary Wire Connection using Receiver Collar.....	16
Test Receiver Collar in YardMax™ Mode.....	16
Test Receiver Collar in Traditional Mode	17
Install the Boundary Wire	18
Place the Boundary Flags.....	19
Fit the Receiver Collar	19
Training Guide	21
Be Patient With Your Pet.....	21
Day 1 - Boundary Awareness	21
Days 2 thru 4 - Continue Boundary Awareness.....	22
Days 5 thru 8 - Distraction Phase	22
Days 9 thru 14 - Unleashed Supervision	23
Days 15 thru 30 - Pet Monitoring.....	23
Working with PetSafe® Pawz Away® Pet Barriers	24
Accessories.....	24
Additional Information	24
Frequently Asked Questions	25
Troubleshooting	25
System Test	27
Wire Break Location Test.....	28
Terms of Use and Limitation of Liability	29
Compliance	29
Customer Care International.....	30
Warranty	30
Layout Grid.....	32

Components

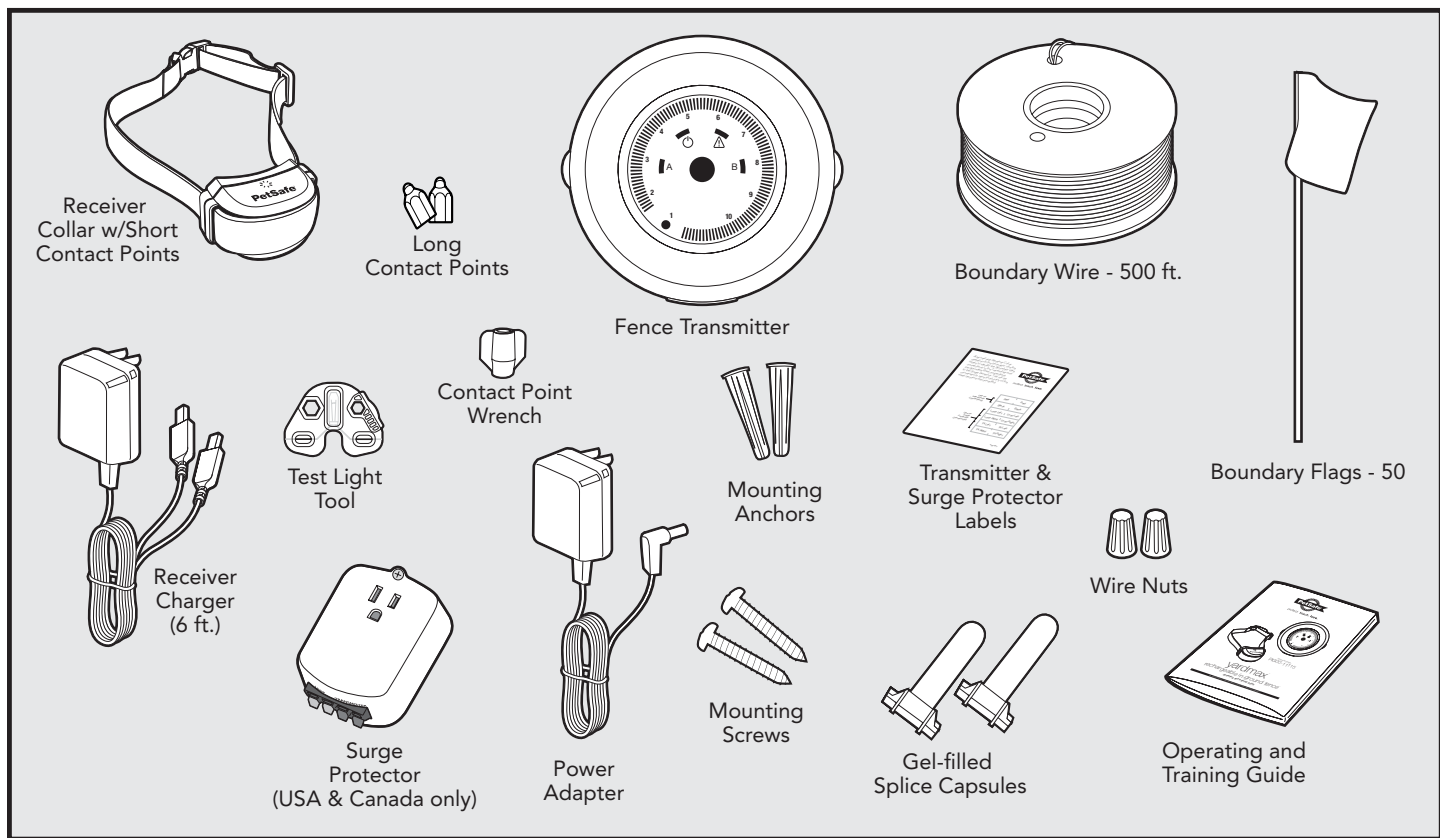

Other Items You May Need

- Additional wire and flags (Part # PIG00-13769)
- Tape measure
- Small Phillips screwdriver
- Drill
- Spade shovel or lawn edger
- Pliers
- Wire stripping pliers
- Scissors
- Lighter
- Electrical Tape
- Additional wire nuts and gel-filled splice capsules
- Waterproofing compound (e.g. silicone caulk)
- PVC pipe or water hose
- Circular saw with masonry blade
- Staple gun
- Non-metallic collar and leash

Fence installation and training help: www.petsafe.net

Want professional installation help? Invisible Fence® Brand installers will come to your home and install your new PetSafe® System for an additional cost. Contact your local dealer at 1-877-866-DOGS (3647) or visit our website at www.invisiblefence.com for more information.

How the System Works

The YardMax™ Fence Transmitter sends a radio signal through a buried wire, marking the boundaries you wish to set for your dog. Your dog wears a Receiver Collar that detects the signal at the boundary. The Receiver Collar offers 5 levels of correction plus tone-only, adjustable to your dog's temperament. The Fence Transmitter operates in two modes: YardMax™ or Traditional.

In YardMax™ mode, the Receiver Collar issues a warning tone when your dog crosses the Boundary Wire. If your dog continues beyond the boundary, the Receiver Collar issues a correction to persuade your dog to return to the Pet Area. Even if your dog continues beyond the Static Correction Zone, the Receiver Collar continues correction giving your dog the perception of an endless boundary. The YardMax™ mode is ideal for small yards as it allows your dog use of up to 30% more of the Pet Area.

In Traditional Mode, the Receiver Collar issues a warning tone when your dog approaches the Boundary Wire entering the Warning Zone. If your dog continues further, he receives a safe but startling Static Correction. While harmless, the correction will persuade him to stay in the containment area you've established.

The PetSafe® YardMax™ Rechargeable In-Ground Fence™ has been proven safe, comfortable and effective for dogs over 5 pounds.

YardMax™ Mode Boundary

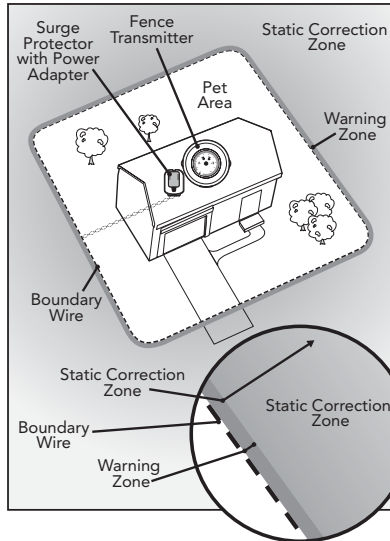

Traditional Mode Boundary

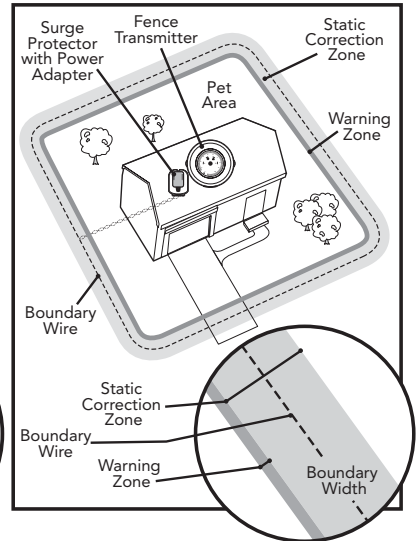

Key Definitions

- Fence Transmitter:** The system's control center that transmits the radio signal through the Boundary Wire.
- Receiver Collar:** Detects the radio signal in the Boundary Wire issuing warning or correction as necessary.
- Receiver Collar Charger:** Charges the batteries inside the Receiver Collar.
- Pet Area:** Area within the boundary wire where your dog can roam freely.
- Warning Zone:** Outer edge of the Pet Area where the Receiver Collar warns your dog not to go into the Static Correction Zone.
- Static Correction Zone:** Area beyond the Warning Zone where your dog's Receiver Collar emits a correction, signaling him to return to the Pet Area.
- Boundary Width Dial:** Controls the distance from the wire that the radio signal is emitted to define boundaries.
- Boundary Width:** The area on each side of the boundary wire within range of the radio signal.
- Receiver Indicator Light:** Reflects the battery status and correction type.
- Contact Points:** Deliver the correction when your dog moves into the Static Correction Zone.
- Mode Button:** Turns Receiver ON/OFF and adjusts the level of Static Correction your pet receives in the Static Correction Zone.
- Power Jack:** Where the Power Adapter plugs into the Fence Transmitter. The Fence Transmitter is powered by a standard 120-volt outlet.
- Power Switch:** Fence Transmitter ON/OFF switch.
- YardMax™ Fence Mode (A/B) Switch:** Allows you to select YardMax™ (Setting A) or Traditional (Setting B) mode.
- YardMax™ Mode:** Sets Warning Zone to start at the Boundary Wire.
- Traditional Mode:** Sets the Warning Zone to the Boundary Width as defined by the Fence Transmitter.
- Loop Wire Terminals:** Where the Boundary Wires connect to the Fence Transmitter in order to complete a continuous loop.

Fence Transmitter

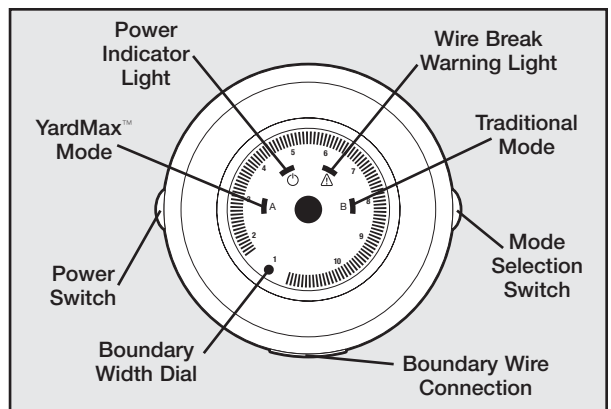

Receiver Collar

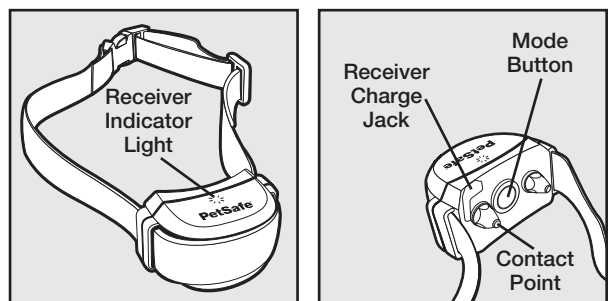

Operating Guide

Step 1 Install the Fence Transmitter

Place the Fence Transmitter:

- In a dry, well ventilated, protected area (1A, 1B).
- In an area where temperatures do not fall below freezing (e.g., garage, basement, shed, closet).
- Secured to a stationary surface using supplied mounting hardware.
- At least 3 feet from large metal objects or appliances as these items may interfere with the signal consistency (1C).
- In an area that can be accessed easily so that you can hear and respond to alarms.

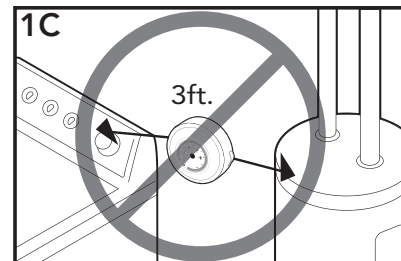
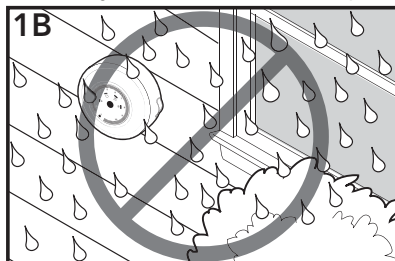
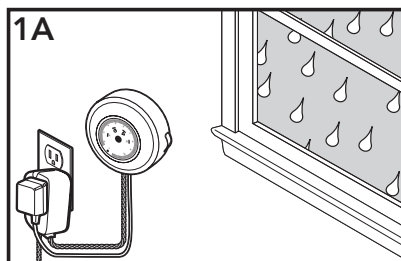

To Install the Fence Transmitter

1. Remove the mounting bracket from the back of the Fence Transmitter.
2. Using the screws provided, mount the mounting bracket to the wall within 5 feet of a standard, grounded (3-prong) outlet.
3. Slide the Fence Transmitter over the mounting bracket.

Once you have mounted the Fence Transmitter, the Boundary Wire must exit the building. This can be accomplished via a window or through a hole drilled through the wall. Ensure the drill path is clear of any utilities. Make sure the Boundary Wire is not cut off or pinched by a window, door, or garage door, as this can damage it over time.

To prevent fires and electrical hazards, install the Fence Transmitter in buildings that are in accordance with state and local electrical codes.

Step 2 Charge the Receiver Collar

To Charge the Receiver Collar

1. Lift the rubber cover protecting the Receiver Charging Jack.
2. Connect the Receiver Collar Charger connector to the Receiver Charging Jack. *Note: The connector only fits one way, do not force it into the Charging Jack.*
3. Plug the Receiver Collar Charger into a standard AC wall outlet. The Receiver Collar light will glow red when the charger is properly seated and charging.
4. Charge the Receiver Collar for 2-3 hours. The light will turn green when charging is complete. A built in safety circuit prevents the Receiver Collar from overcharging.
5. After charging, replace the rubber cover to protect the Receiving Charging Jack.

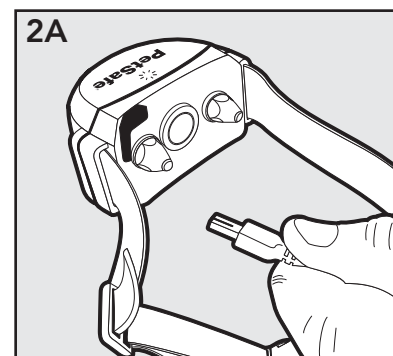

Each charge can last up to three months depending on frequency of use.

NOTICE

Do not charge your Receiver Collar every night. Frequent charging can have a negative effect on the battery. We recommend that the Receiver Collar be used until the Receiver Indicator Light blinks yellow or red.

Step 3

Prepare the Receiver Collar

Your Receiver Collar comes with short Contact Points installed. Use the long Contact Points for dogs with long or thick hair. Tighten the Contact Points using the Contact Point Wrench (3A). Check the tightness weekly. The Receiver Collar is waterproof.

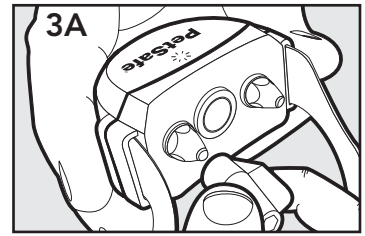

To Turn On the Receiver Collar

Press and hold the Mode Button for 1 second (3B). The green or yellow or red Receiver Indicator Light will turn ON for 5 seconds (3B) to indicate battery status, followed by the red Receiver Indicator Light flashing the Static Correction Level.

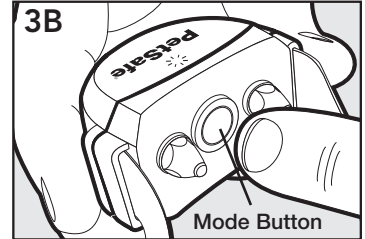

To Turn off the Receiver Collar

Press and hold the Mode Button continuously for 5 seconds. The red Receiver Indicator Light will be ON during this time. The red Receiver Indicator Light will then turn OFF and all Receiver Indicator Lights will stay OFF indicating that the unit is turned OFF. To extend the time between charging the Receiver Collar, consider turning OFF the Receiver Collar when it is not in use.

Receiver Collar Status Indicators

The Receiver Collar Status Indicator Light along with the alarm tones are used to determine the operational mode, the battery status, and the correction type. Refer to the Receiver Collar Status Indicator Table below to understand the status lights and tones for the Receiver Collar. During normal operation, the Receiver Collar Indicator Light will flash every 4 seconds to indicate the battery status as shown in the table below.

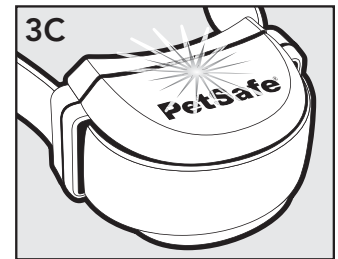

Receiver Collar Status Indicator Table

Status Light	Alarm Tone	Condition
While Plugged Into Receiver Charger		
Solid Red	No Tone	Charge in progress
Solid Green	No Tone	Charge complete
No Light	No Tone	Charge failure, contact Customer Care Center
After Removing From Charger Or Turning On Performs ReadyTest®		
Off (1 second)	No Tone	Unit is performing ReadyTest®
Continuous Green or Yellow or Red (5 seconds)	No Tone	Battery Charge Indicator
Continuous Red	20 sec.	ReadyTest® failure; unit is not operational, contact Customer Care Center
Static Correction Report Level		
Flashing Red from 1 to 6 times	No Tone	Receiver Collar is reporting Static Correction level from 1 to 6
PerfectFit™ Test		
Flashing Yellow (every 1 second)	No Tone	Unit is in PerfectFit™ mode for 90 sec. after turning on
Flashing Green (every 1 second)	Chime; 5 consecutive chimes for confirmed fit	PerfectFit™ mode indicates collar is making true contact with dog's skin
Receiver Activation Status		
Fast Pulsating Green	Warning Tone	Warning tone
Fast Pulsating Red	Duration of the Correction	Static Correction being delivered (up to 10 sec.)
Continuous Green (10 seconds)	No Tone	Over Correction Protection; collar locked for 10 sec.
Slow Blinking Green (every 4 seconds)	No Tone	Collar battery charge 100% - 60%
Slow Blinking Yellow (every 4 seconds)	No Tone	Collar battery charge 60% - 20%
Slow Blinking Red (every 4 seconds)	No Tone	Collar battery charge 20% or less; charge immediately

ReadyTest® Feature

ReadyTest® gives you added confidence that the Receiver Collar is working and ready to use. When you remove the Receiver Collar from the charger, or turn the Receiver Collar ON, the Receiver Collar will automatically go into self-test mode for approximately 8 seconds. The receiver's internal diagnostics will check that the battery charge is full and that all circuits are working correctly.

Do not touch the Contact Points while the Receiver Collar is in test mode. When the collar is removed from the charger, or turned on, the indicator light will go off for 1 second. The indicator light will come back on for five seconds to indicate the status of the battery (green, yellow or red). The ReadyTest™ is complete once you see the battery indicator status.

If the Receiver Collar beeps and the indicator light glows solid red for 20 seconds, the ReadyTest® has detected a problem. Turn the Receiver Collar on and repeat the test. If the Receiver Collar continues to fail the ReadyTest®, call the Customer Care Center.

PerfectFit™ Test for Collar Fit

This test is an added feature to verify fit but is not required for the system to function. After the ReadyTest®, the Receiver Collar will go into PerfectFit™ test mode. This mode begins with a flashing yellow light. To use this feature, you must place the Receiver Collar on your dog within 90 seconds of disconnecting the charger from the Receiver Charging Jack or turning the Receiver Collar ON. The Receiver Collar will emit an alarm tone as the Contact Points touch your dog's skin. You will know you have the proper fit when the collar tones and flashes green 5 consecutive times. After 90 seconds, the Receiver Collar moves into normal operation mode.

Set the Static Correction Level

The Static Correction levels increase in strength from 1 to 6. Refer to the table below to choose the Static Correction that best fits your dog. The Receiver Collar will emit a Warning Tone whenever your dog enters the Warning Zone, no matter what correction level is selected. If your dog continues into the Static Correction Zone, and the Receiver Collar is set to level 2 or above, your dog will receive a correction.

1. Press the Mode Button and release (**3B**) when the Receiver Indicator Light illuminates Red (**3C**).
2. The Receiver Indicator Light will emit a series of Red Flashes representing the Static Correction Level.
3. Increase the Static Correction Level by pressing and releasing the Mode Button within 5 seconds of the previous series of flashes.

Static Correction Level Table

Indicator Light	Static Correction Level	Receiver Collar Function	Dog Temperment
1 flash	1	No Static Correction, Tone only	Initial Training Mode
2 flashes	2	Low Static Correction	Timid
3 flashes	3	Medium-Low Static Correction	Timid or Average
4 flashes	4	Medium Static Correction	Average Energy
5 flashes	5	Medium-High Static Correction	Average or High Energy
6 flashes	6	High Static Correction	High Energy

Anti-Linger Prevention

The Anti-Linger Prevention feature keeps your dog from staying in the Warning Zone for long periods of time and draining the Receiver Collar rechargeable battery. Your dog will hear a two second warning tone when he reaches the Warning Zone. If your dog does not return to the Pet Area after two seconds, he will receive a continuous Static Correction until he returns to the Pet Area.

Run Through Prevention

In YardMax™ mode when your dog crosses over the wire and passes the Warning Zone, Static Correction is activated at a variable distance dependent on the height of the dog and the height of the Receiver activation distance setting. For example, A dog 2.5 feet tall with activation height 1.5 feet above his neck (described in Step 8A) would detect a warning tone distance of about 2.5 feet before Run-Through Prevention would occur.

In Traditional Mode, this system includes a unique "run-through" prevention so that your dog cannot escape the Pet Area without receiving an increased level of Static Correction. The Receiver Collar automatically increases the Static Correction when your dog continues more than 20% of the way through the Warning Zone.

For example, if the signal is detected 10 feet from the wire and your dog enters the Static Correction Zone, this feature is activated when he is approximately 8 feet from the Boundary Wire. Your dog will then receive a Static Correction that is at an increased level corresponding to the Static Correction level setting on the Receiver Collar.

Over Correction Protection

YardMax™ mode: In the unlikely event that your pet "freezes" or continues beyond the boundary, the Static Correction duration continues for 15 seconds. The Receiver Collar locks out further Static Correction and the green light will remain on for 10 seconds. The Receiver Collar remains locked out until the pet re-enters the Pet Area.

Traditional Mode: In the unlikely event that your pet "freezes" in the Static Correction Zone, this feature limits the Static Correction duration to 15 seconds. While the Receiver Collar locks out further Static Correction, the green light will remain on for 10 seconds.

Step 4

Lay Out the System

Determine Fence Transmitter Mode

Use YardMax™ Mode (setting A) if you:

- Have a small yard - gain up to 30% more yard for your pet
- Require strong No Run Through protection
- Need a single perimeter loop around your property

Use Traditional Mode (setting B) if you:

- Need exclusion areas to keep your dog out of gardens, pools and landscaping
- Need to use a double loop layout

Basic Planning Tips

- Design a layout that is suitable for your yard.
- Sample layouts are provided in this section, and a grid for designing your layout is available in the back of this guide.
- The Boundary Wire MUST start at the Fence Transmitter and make a continuous loop back to it (4A).
- Twisting the Boundary Wire cancels the signal and allows your dog to cross over that area without correction. Plastic or metal piping will not cancel the signal. Twist the Boundary Wire 10 to 12 times per foot to cancel the signal (4A).
- Always use gradual turns at the corners with a minimum of 3 foot radius to produce a more consistent boundary (3B). Do not use sharp turns, as this will cause gaps in your boundary.
- Avoid making passageways too narrow for your pet to move about freely (e.g., along the sides of a house).
- For your dog's protection, we recommend setting a Boundary Width for the Warning and Static Correction Zones to approximately 16 - 24 feet (8 - 12 feet on each side of the wire) when using Traditional Mode.
- YardMax™ mode layouts need to be at least 10 feet from neighboring YardMax™ In-Ground Fence Systems.

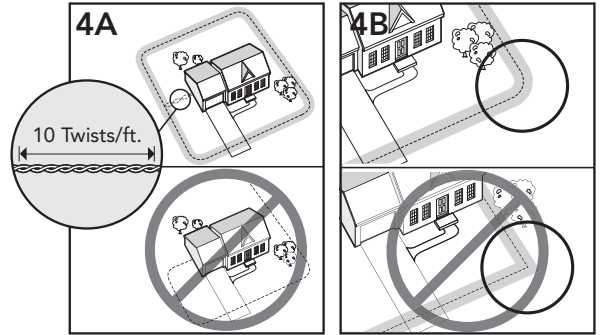

YardMax™ Mode Layouts

Sample 1 (4C): Perimeter Loop (Single Loop) YardMax® is ideal for a perimeter loop. This will allow your dog to freely and safely roam your entire property.

Sample 2 (4D): Perimeter Loop Using Existing Fence (Single Loop) This layout allows you to include your existing fence as part of your layout and keep your pet from jumping out or digging under your existing fence. It reduces the amount of wire which will need to be buried.

Using either Sample 1 or 2, from the Fence Transmitter, run the wire to **A**, **A** to **B**, **B** to **C**, **C** to **D**, **D** to **E**, **E** to **A**, twist the wires from **A** back to the Fence Transmitter.

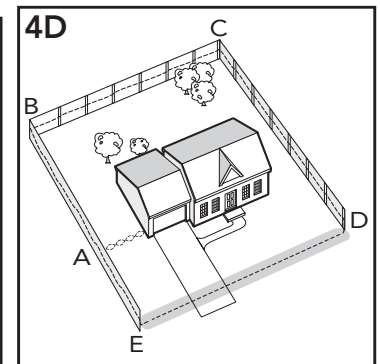
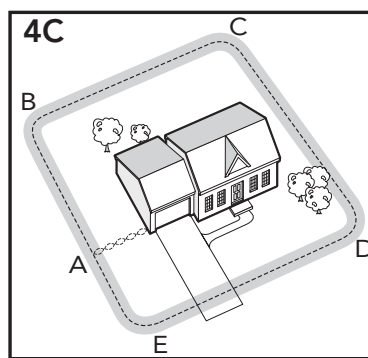

Traditional Mode Layouts

Both sample layouts above may be also be used in Traditional Mode (4C, 4D).

Sample 3 (4E): Perimeter Loop with Exclusion Areas (Single Loop) This layout allows you to keep your dog out of gardens, pools or landscaping within your yard.

A Double Loop layout must be used when you are not establishing the Boundary Zone on all sides of your property. When using a Double Loop, the Boundary Wire must be separated by a minimum of **approximately 5 FEET** to avoid canceling the signal. Keep in mind that a Double Loop will require twice as much wire.

When using Traditional Mode, the Receiver Collar may be activated inside the house if the Boundary Wire runs along the outside wall of the house. If this occurs, remove your dog's Receiver Collar before bringing him inside, decrease the range using the Boundary Width Dial or consider an alternative layout.

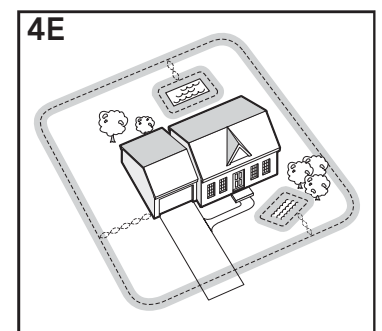

Sample 4 (4F): Front or Back Yard Only (Double Loop)

From the Fence Transmitter, run the wire to **A**, **A** to **B**, **B** to **C**, **C** to **D**, **D** to **E**, **E** to **F**, make a U-turn and follow your path all the way back to **A**, keeping the wire separated **by at least 5 feet**. Twist the wire from **A** back to the Fence Transmitter.

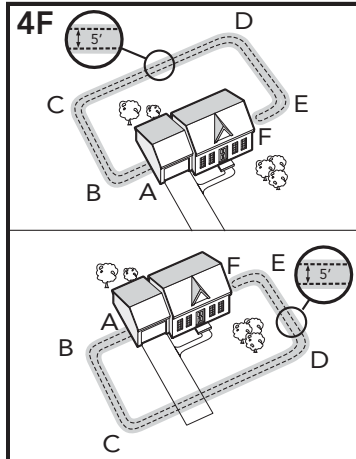

Sample 5 (4G): Front Boundary Only (Double Loop)

From the Fence Transmitter, run the wire to **A**, **A** to **B**, **B** back to **A** keeping the wire separated **by at least 5 feet**. Twist the wire from **A** back to the Fence Transmitter.

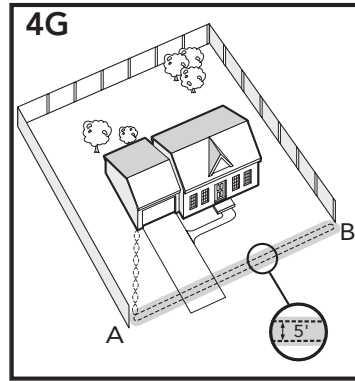

Sample 6 (4H): Lake Access (Double Loop)

From the Fence Transmitter, run the wire to **A**, **A** to **B**, make a U-turn and go to **C**, **C** to **D**, **D** to **E**, make a U-turn and follow your path all the way back to **A** keeping wire separated **by at least 5 feet**. Twist the wire from **A** back to the Fence Transmitter.

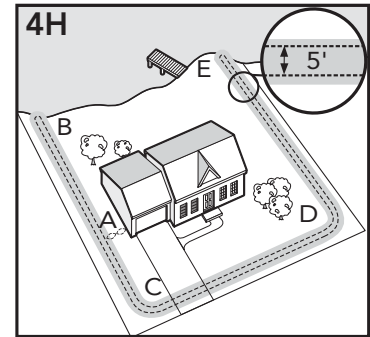

Sample 7 (4I): Wire Loop Attached to Existing Fence (Double Loop) This layout allows you to include your existing fence as part of your layout and keep your pet from jumping out or digging under your existing fence. It reduces the amount of wire which will need to be buried. Run the wire from the Fence Transmitter to **A**, **A** to **B**, **B** to **C**, **C** to **D**, **D** to **E**, **E** to **F**, make a U-turn and follow your path all the way back to **A**, keeping the wire separated **by at least 5 feet**. Twist the wire from **A** back to the Fence Transmitter.

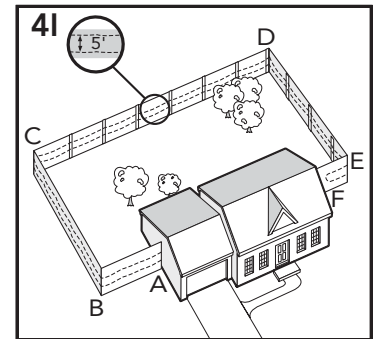

Step 5 Position the Boundary Wire

Lay out the Boundary Wire using your planned boundary and test the system **BEFORE** burying the wire or attaching it to an existing fence. This will make any layout changes easier. Work carefully. A nick in the wire insulation can diminish the signal strength and create a weak area where your dog can escape. Ensure you have at least 10 feet between the wire and dangerous areas such as the street.

Running the Boundary Wire parallel to and within 10 feet of electrical wires, neighboring containment systems, telephone wires, television or antenna cables, or satellite dishes may cause an inconsistent signal. If you must cross any of these, do so at 90-degree angles (perpendicularly) (5A).

If separating the wire by at least 10 feet from a neighboring containment system's wire does not reduce the inconsistent signal, contact the Customer Care Center.

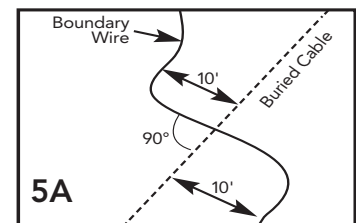

⚠ WARNING

Underground cables can carry high voltage. Have all underground cables marked before you dig to bury your wire. In most areas, this is a free service. Avoid these cables when you dig.

To Twist the Boundary Wire

Twisting the wire cancels the signal allowing your pet to cross over that area safely (5B). To ensure the signal is cancelled, it is recommended that you cut and splice the wire between each twisted section. The signal cannot be cancelled by running the wire through plastic or metal piping. Splicing shielded cable to the wire will also not cancel the signal. Refer to figure (5C) for the correct method for twisting the wire. You can twist your own wire by cutting two equal lengths of wire supplied and twisting them together. Anchor one end of the wires to something secure and insert the other end in a power drill. Pull the wire taut. The drill enables you to twist the wire quickly. Twist the wire 10 to 12 times per foot to cancel the signal. Once you have completed your boundary layout, insert the twisted wire into the transmitter.

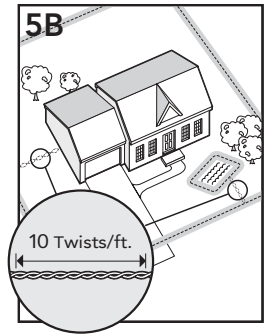

To Splice or Repair the Boundary Wire

If you need additional Boundary Wire to expand your wire loop, you will need to splice the wires together. Note the locations of all splices for future reference.

Strip approximately $\frac{3}{8}$ inch of insulation off the ends of the wires to be spliced (5D). Make sure the copper Boundary Wire is not corroded. If the wire is corroded, cut it back to expose clean copper wire. Insert the stripped ends into the wire nut and twist the wire nut around the wires. Ensure that there is no copper exposed beyond the end of the wire nut. Tie a knot 3 to 4 inches from the wire nut (5E). Ensure that the wire nut is secure on the wire splice.

Once you have securely spliced the wires together, open the lid of the gel-filled splice capsule and insert the wire nut as deeply as possible into the waterproof gel inside the capsule (5F). Snap the lid of the capsule shut (5G). For proper system performance, the splice connection must be waterproof. If your splice pulls loose, the entire system will fail. Make sure your splice is secure. Additional gel-filled splice capsules and wire nuts are available through the Customer Care Center.

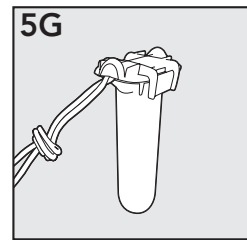
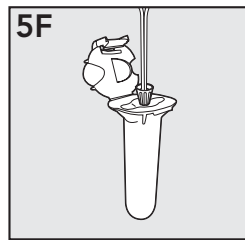
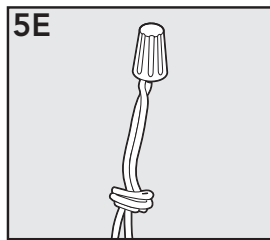
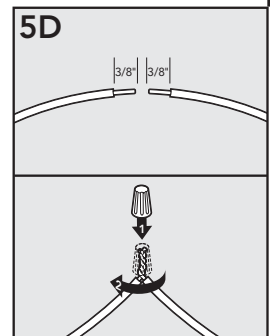
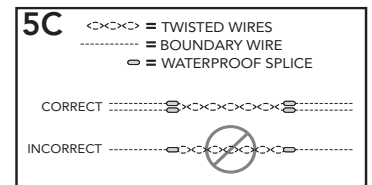

Additional Boundary Wire

Extra direct burial Boundary Wire can be purchased in 500 foot spools at the store where you purchased the kit or through the Customer Care Center.

Note: When adding wire, it must act as a continuous loop.

The table at right indicates the approximate length of Boundary Wire needed for a square, Single Loop layout. Length will vary due to the amount of twisted wire and layout used.

Acres	Feet of Wire Needed
1/4	415
1/3	480
1/2	590
1	835
2	1180
5	1870
10	2800

Step 6

Install the Surge Protector & Connect the Wires

Surge Protection

Lightning strikes that occur even several miles away from your installation can create power surges or spikes which may damage your unprotected electronic pet containment system. The Surge Protector included with this system is designed to protect your YardMax™ Rechargeable In-Ground Fence™ from surges or spikes that can reach it via your AC power connection and/or Boundary Wire.

⚠ WARNING

- Do not install, connect, or remove your system during a lightning storm. If the storm is close enough for you to hear thunder, it is close enough to create hazardous surges.
- Risk of electric shock. Use the Fence Transmitter and Surge Protector indoors in dry location only.
- Turn off power to the outlet before you install or remove your Surge Protector.
- Risk of electric shock or fire. Use Surge Protector only with a duplex outlet with center screw.

⚠ CAUTION

- Do not install the Surge Protector if there is not at least 30 feet (10 meters) or more of wire between the electrical outlet and electrical service panel.
- If possible, DO NOT use an AC circuit protected with a GFCI (ground fault circuit interrupter). Both the Surge Protector and the fence system will function. However, in rare cases, nearby lightning may cause the GFCI to trip. Without power, your dog may escape. You will have to reset the GFCI to restore power to the system.

NOTICE

- Plug the Surge Protector into a grounded (3-prong) outlet within 5 feet of the Fence Transmitter. ALWAYS use a grounded (3-prong) outlet to ensure protection.
- Do not remove the ground prong from the Surge Protector plug. Do not use a 3-prong plug to 2-prong outlet converter. Doing so will make the Surge Protector ineffective against surges or spikes.
- For added protection, when unused for long periods of time or prior to thunderstorms, unplug from the wall outlet and disconnect the Loop Boundary Wires. This will prevent damage to the Transmitter due to surges.

1. Turn the power OFF to the outlet to which the Surge Protector and Fence Transmitter is connected (6A).
2. Remove the outlet center screw that holds the cover plate in place.
3. Plug the Surge Protector into the lower outlet.
4. Secure the Surge Protector to the outlet and cover plate using the long screw provided.
5. Run the Boundary Wire through a window, under a door, through a crawl space vent, or any other appropriate available access. You can also drill a hole through your wall.
6. Strip $\frac{3}{8}$ inch of insulation from the ends of the Boundary Wire.
7. Insert the stripped ends into the 2 left red connector holes on the bottom of the Surge Protector labeled "Loop" (6B).
8. Depress the plastic tab, insert the wires and release the tab. Make sure the wires do not touch each other at the terminals.

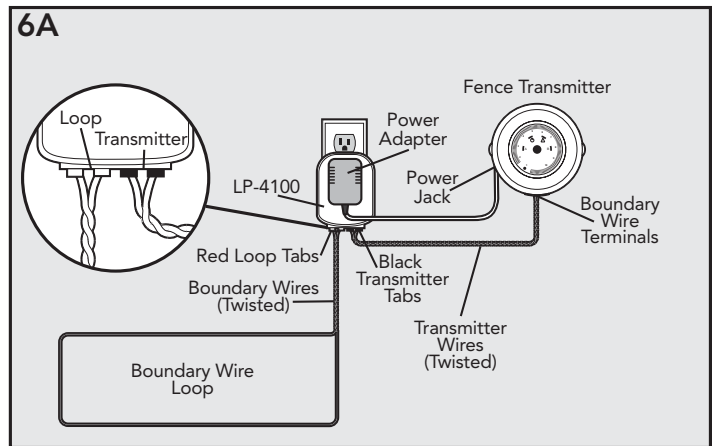

NOTICE

Verify that the boundary loop and transmitter wires connect to the proper Surge Protector terminals. Reversed connections will result in an increased risk of surge related damage.

9. Determine the length of wire needed to pass from the Surge Protector to the Fence Transmitter. Measure and cut 2 lengths of wire, then strip $\frac{3}{8}$ inch of insulation at both ends. Twist the 2 lengths together, with at least 10-12 twists per foot, so the wires will not send out a signal.
10. Insert the ends of the twisted transmitter wires into the right 2 black connectors at the bottom of the Surge Protector labeled "Transmitter".
11. Push the tab on the Fence Transmitter to insert the opposite ends of the twisted wire into the Loop Wire Terminals.
12. Plug the Fence Transmitter power adapter into the outlet on the front of the Surge Protector.
13. Turn the Fence Transmitter ON. The Indicator Light on the Transmitter should illuminate to green indicating a properly installed boundary loop. If the alarm sounds and Warning Light illuminates red, check the connections to make sure there isn't an open circuit. If still not operating correctly, refer to the "Troubleshooting" section in this guide.

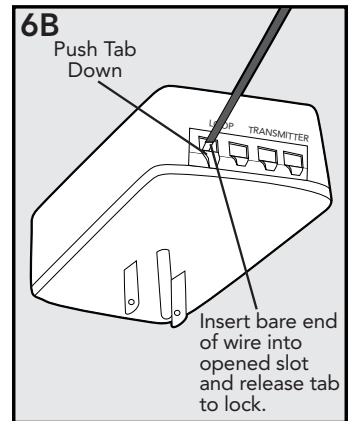

Fence Transmitter Indicator Light Status Table

Status Light	Condition
Solid Green	Power On
Red	Boundary Wire Broken/Disconnected
None	Transmitter is OFF or Power is Disconnected

Step 7

Verifying Transmitter Boundary Wire Connection using Receiver Collar

With the Boundary Wire in place and properly connected and the Receiver Collar fully charged, it is time to test the system. This step needs to be completed for both YardMax™ and Traditional Modes.

CAUTION

- The Receiver Collar should NOT be on your dog when the system is tested. Your pet may receive an unintended correction.
- To prevent an unintended correction for your pet, test the boundary location and width after any change.

Testing the system ensures you have signals in proper direction to contain your pet. If wire is reversed, go back to Fence Transmitter and swap the wires going into red and black connectors.

1. Power the Fence Transmitter ON.
2. Set Fence Transmitter Mode (A/B) Switch to A (YardMax mode)
3. Set the Boundary Width Dial to 3.
4. Select a section of straight Boundary Wire that is at least 50 feet long.
5. Set Receiver Collar to Correction Level 6 (refer to Step 3).
6. Place the Test Light Tool Contacts on the Contact Points of the Receiver Collar (7A, 7B).
7. Hold the Receiver Collar with the Contact Points pointing up (7C) on the receiver facing the Boundary Wire.
8. Start inside the Pet Area approximately 5 feet from the Boundary Wire. Test the Boundary by approaching and crossing the boundary wire as shown (7D). As you cross the wire, you will hear the Warning Tone and see the test light flash as you continue to walk further. If you don't hear the warning tone, turn around and walk back across the Boundary Wire into the Pet Area to see if it tones in that direction as the wire may be reversed. If so, reverse the wires at the connector to the Fence Transmitter. Do not adjust the wires connected to the Surge Protector. Then, repeat the test.
9. After verifying Receiver Collar operation at the boundary, use the labels (7E) to identify the wire connections to the Fence Transmitter and the Surge Protector. This will be convenient to have should any of the wires become disconnected.

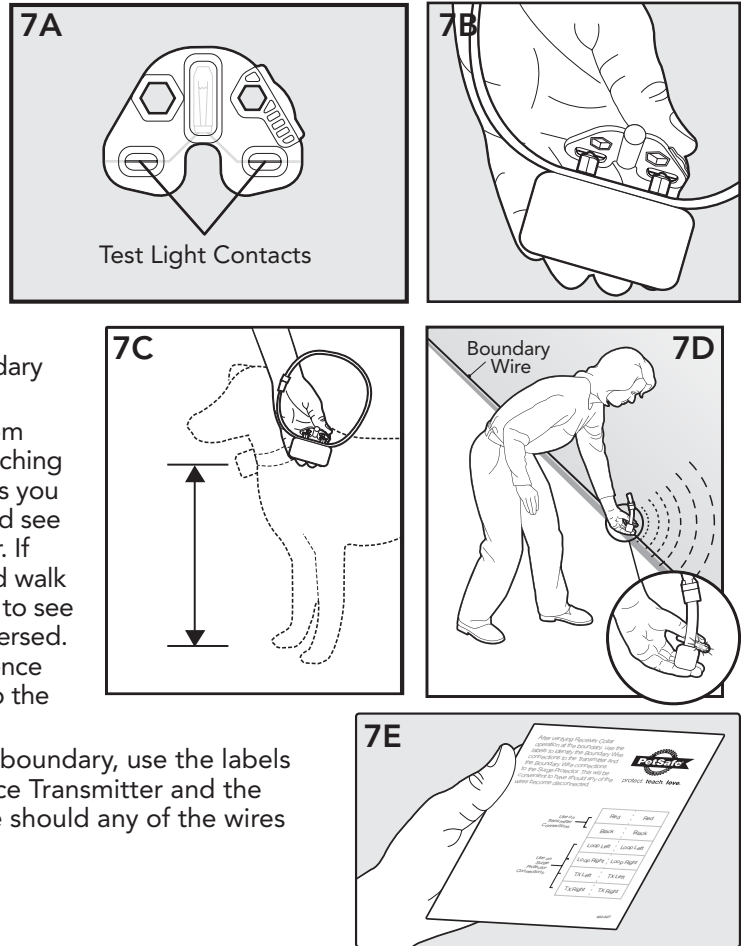

Step 8A

Test Receiver Collar in YardMax™ Mode

CAUTION

- In YardMax™ mode, excessive snowfall (>1.5 ft) may place your dog outside the signal field allowing your dog to leave the Pet Area. You may need to switch to Traditional Mode or increase the boundary width until the snow recedes.

1. Verify that Fence Transmitter is set to Mode A, YardMax mode.
2. Power the Fence Transmitter ON.
3. Select a section of straight Boundary Wire that is at least 50 feet long.
4. Set the Receiver Collar to Level 6.
5. Place the Test Light Tool contacts on the Contact Points of the Receiver Collar (7A, 7B). Hold the Receiver Collar with the Contact Points pointing up (7C), facing the Boundary Wire.
6. Hold the Receiver Collar 1 to 1 ½ feet above your dog's neck height. If you have multiple dogs, use the neck height of your tallest pet. Note: Minimum adjustment height is 30 inches. Toy breeds less than 15 inches in height, set Boundary Width Dial on Fence Transmitter to #1 position.
7. Begin with the Boundary Width Dial on the Fence Transmitter set to the #1 position.
8. Start inside the Pet Area, slowly approach the Boundary Wire, when you cross the Boundary Wire, the Receiver Collar should tone. If this is too low and you do not hear the tone or see the test light flash, increase the transmitter dial setting by 1. Keep adjusting the transmitter dial until it is set where the Receiver Collar tones only when it is within 1 to 1 ½ feet above your dog's neck height at the boundary.

9. Once this setting is determined, set Fence Transmitter to Mode B, Traditional Mode. Hold Receiver Collar as close to the ground as possible. Walk all over the Pet Area where the pet should be free to play. If you come across areas where the Receiver Collar activates with tone and or Static Correction, you will need to try adjusting your layout where the Boundary Wire crosses cable, telephone or power wires as shown in **5A**. If you still cannot correct this problem, you will need to use the Traditional Mode Transmitter setting for your layout.
 10. If your layout checks out well, and you plan to use YardMax™ mode, slide Fence Transmitter switch back to A, YardMax™ mode.
 11. Adjust your Receiver Collar setting to Level 1 for tone only training.
- Once you are satisfied that your system is functioning properly, you are ready to start burying the Boundary Wire.

Step 8B

Test Receiver Collar in Traditional Mode

1. Power the Fence Transmitter ON.
2. Set Fence Transmitter Mode (A/B) Switch to B (Traditional Mode).
3. Set the Boundary Width Dial to the 7 as the starting position.
4. Test the Boundary Width by selecting a section of straight Boundary Wire that is at least 50 feet long. Start inside the Pet Area.
5. Set the Receiver Collar to Level 6.
6. Place the Test Light Tool Contacts on the Contact Points of the Receiver Collar (**7A, 7B**). Hold the Receiver Collar with the Contact Points pointing up (**7C**), at your dog's height, and facing the Boundary Wire.
7. Starting inside the Pet Area, slowly approach the Boundary Wire until you hear the warning tone (**8A**). When you hear the warning tone, you have identified the Boundary Width distance (Static Correction Zone). Two seconds after the warning tone, the test light will begin to flash.

To avoid having the Receiver Collar go into Over Correction Protection mode, walk back into the Pet Area until the beeping stops.

8. Adjust the Boundary Width Dial so that the Receiver Collar tones within the desired range of the Boundary Wire. *To best use the automatic Run-Through Prevention feature, the Boundary Width should extend at least 10 feet from the Boundary Wire (total Boundary Width of 20 feet).*
9. Test in a number of different locations around the pet area until you are satisfied that the system is functioning properly.
10. Next, walk all around the pet area to ensure there are no areas where the Receiver Collar may activate from signals coupled onto buried wires or cables. Test the collar in and around the inside of the house as well. As mentioned, cable and wires from cable TV, electrical or telephone lines may conduct pet fencing signals inside and outside the house that can activate the dog's collar accidentally. While rare, if this occurs, your Boundary Wire should be moved or modified where it crosses these outside lines as shown in Figure **5A**.
11. To test the run-through prevention feature, walk beyond the Boundary Wire. The Receiver Collar should tone and the Test Light should flash. If the Receiver Collar did not tone or the Test Light did not flash, see the "Troubleshooting" section.
12. Adjust your Receiver Collar setting to Level 1 for tone only training.

Once you are satisfied that your system is functioning properly, you are ready to start burying the Boundary Wire.

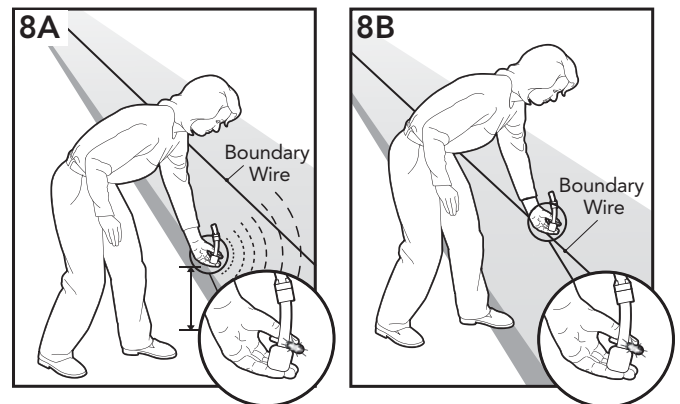

Install the Boundary Wire

⚠ WARNING

- Underground cables can carry high voltage. Have all underground cables marked before you dig to bury your wire. In most areas, this is a free service. Avoid these cables when you dig.
- Before you begin installing the Boundary Wire, turn the Fence Transmitter OFF and unplug the adapter from the Surge Protector.

To Bury the Boundary Wire

Burying the Boundary Wire is recommended to protect it and prevent disabling the system.

1. Cut a trench 1-3 inches deep along your planned boundary.
2. Place the Boundary Wire into the trench maintaining some slack to allow it to expand and contract with temperature variations.
3. Use a blunt tool such as a wooden paint stick to push the Boundary Wire into the trench. Be careful not to damage the Boundary Wire insulation.

To Attach the Boundary Wire to an Existing Fence

The Boundary Wire can be attached to a chain link fence, split rail fence, or a wooden privacy fence. The Boundary Wire can be attached as high as needed. However, make sure the Boundary Width is set at a high enough range for the pet to receive the signal. If using a Double Loop (Traditional Mode only) with an existing fence at least five feet tall, run the Boundary Wire on top of the fence and return it on the bottom of the fence to get the five foot separation needed.

- **Chain Link Fence (9A):** Weave Boundary Wire through the links or use plastic quick ties.
- **Wooden Split Rail or Privacy Fence (9A):** Use staples to attach Boundary Wire. Avoid puncturing the insulation of the Boundary Wire.
- **Double Loop with an Existing Fence:** Run the Boundary Wire on top of the fence and return it on the bottom of the fence to get the five foot separation needed.
- **Gate (Single Loop) (9B):** Bury the Boundary Wire in the ground across the gate opening. *Note: The signal is still active across the gate.* Your pet cannot pass through an open gate.
- **Gate (Double Loop) (9B):** Bury both Boundary Wires across the gate opening while keeping them five feet apart.

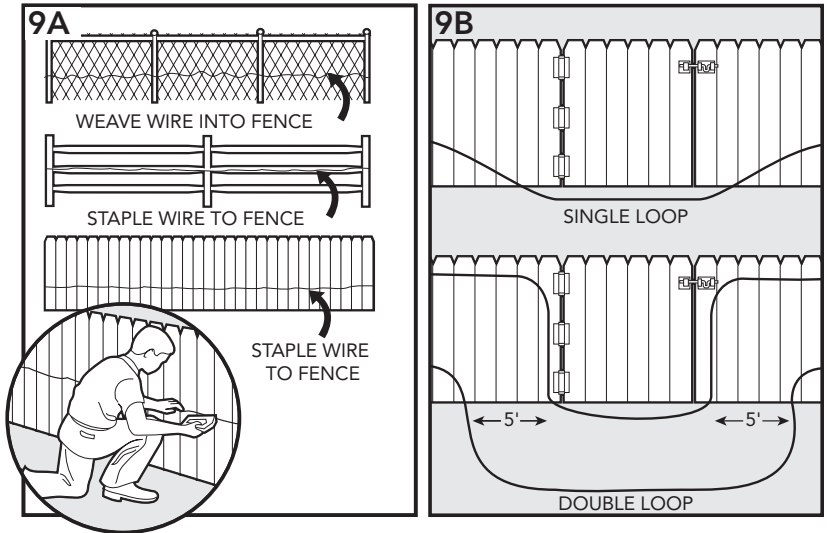

⚠ WARNING Follow all safety instructions for your power tools. Be sure to always wear your safety goggles.

To Cross Hard Surfaces (driveways, sidewalks, etc.)

- **Concrete Driveway or Sidewalk (9C):** Place the Boundary Wire in a convenient expansion joint or create a groove using a circular saw and masonry blade. Place the Boundary Wire in the groove and cover with an appropriate waterproofing compound. For best results, brush away dirt or other debris before patching.
- **Gravel or Dirt Driveway (9D):** Place the Boundary Wire in a PVC pipe or water hose to protect the Boundary Wire before burying.

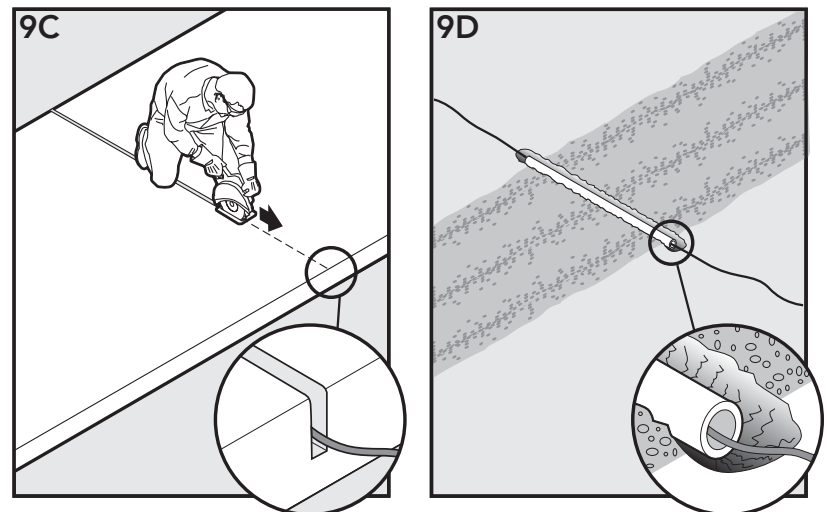

Step 10 Place the Boundary Flags

The Boundary Flags are visual reminders for your pet of where the Warning Zone is located.

YardMax™ mode:

1. Place the Boundary Flag along the Boundary Wire approximately 6 inches inside the Pet Area (10A, 10B).
2. Place a Boundary Flag in the ground every 10 feet.

Traditional Mode:

1. Place the Test Light Contacts on the Contact Points. Hold the Receiver Collar at your pet's neck height.
2. For Traditional Mode, walk towards the Warning Zone until the Receiver Collar beeps (10C).
3. Place a Boundary Flag in the ground (10D).
4. Walk back into the Pet Area until the beeping stops.
5. Repeat this process around the Warning Zone until it is marked with Boundary Flags every 10 feet.

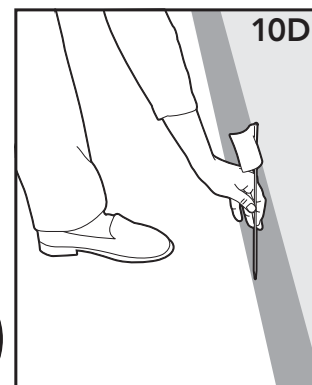
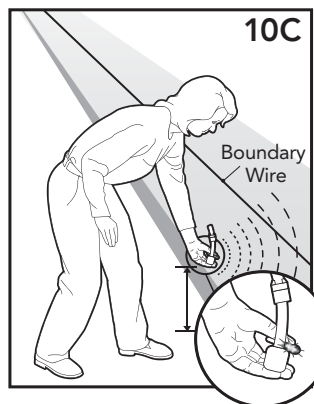
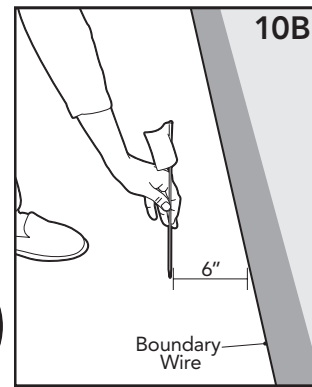
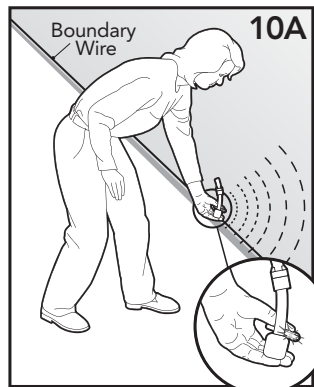

Step 11 Fit the Receiver Collar

Important: The proper fit and placement of your Receiver Collar is important for effective training. The Contact Points must have direct contact with your pet's skin on the underside of his neck.

CAUTION

Please read and follow the instructions in this manual. Proper fit of the collar is important. A collar worn for too long or made too tight on the pet's neck may cause skin damage. Ranging from redness to pressure ulcers; this condition is commonly known as bed sores.

- Avoid leaving the collar on the dog for more than 12 hours per day.
- When possible reposition the collar on the pet's neck every 1 to 2 hours.
- Check the fit to prevent excessive pressure; follow the instructions in this manual.
- Never connect a lead to the electronic collar; it will cause excessive pressure on the contacts.
- When using a separate collar for a lead, don't put pressure on the electronic collar.
- Wash the dog's neck area and the contacts of the collar weekly with a damp cloth.
- Examine the contact area daily for signs of a rash or a sore.
- If a rash or sore is found, discontinue use of the collar until the skin has healed.
- If the condition persists beyond 48 hours, see your veterinarian.
- For additional information on bed sores and pressure necrosis, please visit our website.

These steps will help keep your pet safe and comfortable. Millions of pets are comfortable while they wear stainless steel contacts. Some pets are sensitive to contact pressure. You may find after some time that your pet is very tolerant of the collar. If so, you may relax some of these precautions. It is important to continue daily checks of the contact area. If redness or sores are found, discontinue use until the skin has fully healed.

To assure a proper fit, please follow these steps:

1. Make sure the Receiver Collar is turned off.
2. Start with your dog standing comfortably (11A).
3. Place the Receiver Collar on your pet so that the "PetSafe®" logo is right side up and the receiver is directly under your dog's chin. Center the Contact Points underneath your dog's neck, touching the skin (11B).

CAUTION

You may need to trim the hair in the area of the Contact Points. Never shave the dog's neck; this may lead to a rash or infection.

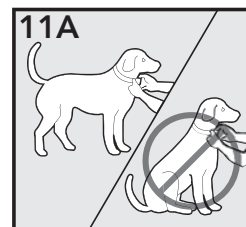

4. Check the tightness of the Receiver Collar by inserting one finger between the end of a Contact Point and your pet's neck. The fit should be snug but not constricting.
5. Allow your dog to wear the collar for several minutes, then recheck the fit. Check the fit again as your dog becomes more comfortable with the Receiver Collar.
6. Once you are satisfied with the fit of the Receiver Collar then you may trim any excess collar strap as follows (11C).
 - a. Mark the desired length of the Receiver Collar with a pen. Allow for growth if your pet is young or grows a thick winter coat.
 - b. Remove the Receiver Collar from your pet and cut off the excess.
 - c. Before placing the Receiver Collar back onto your pet, seal the edge of the cut collar by applying a flame along the frayed edge.

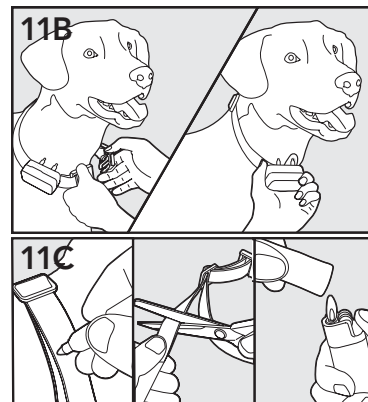

Replacement collar straps are available through the Customer Care Center.

To Re-Thread the Collar

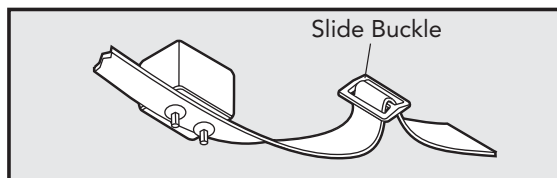

The slide buckle prevents the collar from becoming loose around your pet's neck.

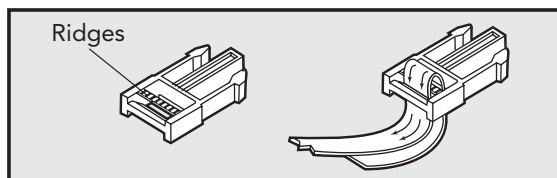

The ridges must be facing up; the collar will slip if it is not properly threaded.

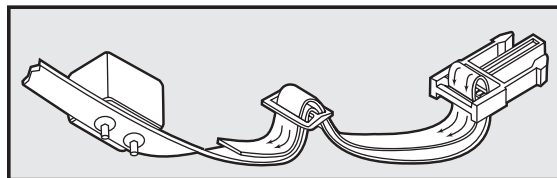

Check the Fit using PerfectFit™ Test

1. To check the fit of the Receiver Collar using the PerfectFit™ test, connect the Receiver Charging Jack to the charger for 5 seconds.
2. Disconnect the charger and wait approximately 8 seconds for the collar to go through the ReadyTest®. Do not touch the Contact Points during the ReadyTest®.
3. Place the collar on your pet and adjust the tightness. The Receiver Collar will emit a tone as the Contact Points touch your dog's skin. You will know you have the proper fit when the collar chimes and flashes green 5 consecutive times.
4. After 90 seconds, the Receiver Collar moves into normal operation mode. If you do not hear the 5 consecutive chimes, tighten the collar and repeat the PerfectFit™ Test.

Training Guide

Be Patient With Your Pet

Important: Proper training of your pet is essential to the success of the Petsafe® YardMax™ Rechargeable In-Ground Fence™.

Read this section completely before beginning to train your pet.

Remember that this PetSafe® YardMax™ Rechargeable In-Ground Fence™ is not a solid barrier.

- Have fun with your pet throughout the training process. Training should be fun, fair, firm and consistent.
- Train for 10 to 15 minutes at a time. Don't try to do too much too quickly. More-frequent short sessions are better than less-frequent longer sessions.
- We suggest a minimum of 14 days of training. Depending on your pet and how he learns, the training could take more or less time.
- If your pet shows signs of stress, slow down the training schedule, add additional days of training, or increase the amount of play time with your pet in the Pet Area. Common stress signals include:
 - **Pet pulling on leash toward the house**
 - **Ears tucked**
 - **Tail down**
 - **Body lowered**
 - **Nervous / frantic movement or stiffening of pet's body**
- Your pet must be completely comfortable near the Boundary Flags at the end of every training session. Spend at least 5 minutes of "play time" at the completion of each session within 10 feet of the Boundary Flags.
- Finish each training session on a positive note with lots of praise and play.
- Remove the Receiver Collar after each training session.
- Be sure to contain your pet by another means during the training period (e.g. pen, tie-out, leash, etc.).
- During training, if you need to take your pet out of the Pet Area, remove the Receiver Collar and either pick your pet up or put him in the car to pass out of the Pet Area.
- Even if you think your pet is responding well to the training, complete the entire training. Reinforcement is important!

Phase

1

Day 1 - Boundary Awareness

Tone-Only Training Mode

Perform three sessions on day one, each training session lasting 10-15 minutes.

Goal: To have your pet learn that the Boundary Flags and warning tone from the Receiver Collar define the new Pet Area.

Setup:

- Program the Static Correction Level to Level 1 Tone-only training mode.
- Put a separate non-metallic collar on your pet's neck ABOVE the Receiver Collar and attach a leash.

CAUTION

Be sure the extra collar does not put pressure on the Contact Points.

- Have tiny pieces of treats that your pet will find desirable available (hot dogs or lunch meat work well).
- Have your pet's favorite play toy available.

Steps:

1. Begin by walking your pet on a leash in the Pet Area. Calmly praise and talk to your pet.
2. Move toward the Boundary Flags (**12A**). Keep your mood happy.
3. With full control of your pet on a leash, walk to the flags. As your pet enters the Static Correction Zone, the Receiver Collar will begin to beep (**12B**). Allow him to stay in the Static Correction Zone for up to 2 seconds then gently help him back into the Pet Area (**12C**). Immediately praise and offer your pet a treat as he enters the Pet Area, even if you have helped with the leash.
4. Repeat this process at the same Boundary Flag until your pet resists going into the Static Correction Zone.
5. Aim to master 3-4 Boundary Flags per session. Make this FUN! Praise if your pet quickly retreats or resists going into the Static Correction Zone. *Note: Never allow your pet to eat the treat in the Static Correction Zone.*

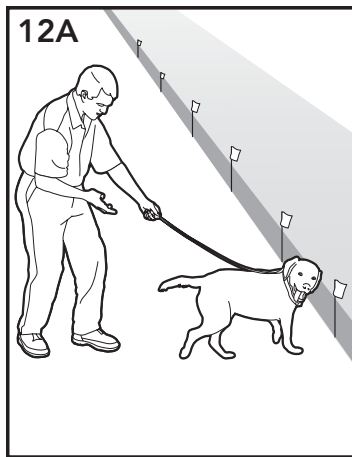

Phase 2 Days 2 thru 4 - Continue Boundary Awareness

Introduction to Static Correction

Perform three sessions per day, each lasting 10-15 minutes.

Goal: To train your pet to stay in the Pet Area and respect the boundary.

Setup:

- Set the Static Correction Level on the Receiver Collar to Level 2.
- Put a separate non-metallic collar on your pet's neck ABOVE the Receiver Collar and attach a leash.

CAUTION

Be sure the extra collar does not put pressure on the Contact Points.

- Have tiny pieces of treats available (hot dogs or lunch meat work well).
- Have your pet's favorite play toy available.

Steps:

1. Repeat steps 1-5 from Phase 1.
2. If your pet does not respond to the Static Correction, confirm that the Receiver Collar is fitting properly according to Step 11.
3. If the Receiver Collar is fitted properly and your pet does not respond to the Static Correction, increase the Static Correction Level by 1. Watch for slight reactions at first such as ears up, head turned, looking at the ground.
4. Stay at the same flag until your pet resists going into the Static Correction Zone.

Phase 3 Days 5 thru 8 - Distraction Phase

Perform three training sessions per day, each lasting 10 to 15 minutes.

Goal: To train your pet to stay within the Pet Area with distractions outside of the Pet Area.

Setup:

- Set the Static Correction Level Receiver Collar to level 2 or higher, depending reactions results from days 2 thru 4. Place the Receiver Collar on your pet.
- Put a separate non-metallic collar on your pet's neck ABOVE the Receiver Collar and attach a leash.

CAUTION

Be sure the extra collar does not put pressure on the Contact Points.

- Have tiny pieces of treats available (hot dogs or lunch meat work well).
- Have your pet's favorite play toy available.
- Create distractions to tempt your pet to enter the Static Correction Zones, such as:
 - Have a family member cross from inside the Pet Area to outside of it.
 - Throw a ball or treat outside of the Pet Area.
 - Have a neighbor walk their pet outside of the Pet Area.
- Gradually increase distraction level. **Never coax or call your pet out of the Pet Area.**

Steps:

1. With full control of your pet on a leash, have the distraction presented.
2. If your pet does not move toward the distraction, praise and offer a treat.
3. If your pet does react to the distraction, allow him to go into the Static Correction Zone.
4. Help your pet back into the Pet Area if he does not turn back after 2 seconds.
5. Treat and praise your pet anytime he comes back into the Pet Area with or without help.
6. Repeat this process with other distractions. Use other family members during this process.
7. If your pet does not respond to the Static Correction, confirm that the Receiver Collar is fitting properly according to Step 11.
8. If the Receiver Collar is fitted properly and if your pet does not respond to the Static Correction, increase the Static Correction Level by 1 setting.

Phase

4

Days 9 thru 14 - Unleashed Supervision

Training sessions should start at 10-15 minutes, gradually increasing to over an hour.

Your pet is ready for this step only when he clearly avoids the entire Static Correction Zone, regardless of any distractions or temptations. During this step, do not leave your pet unattended.

Goal: To give your pet free run of the Pet Area off the leash.

Setup:

Adjust the Static Correction Level to the permanent setting appropriate for your pet.

Steps:

1. Enter the Pet Area with your pet wearing the Receiver Collar.
2. Walk around the yard and play with your pet, staying within the Pet Area at all times.
3. Preoccupy yourself with another task in the yard while watching your pet.
4. Should your pet escape, take the Receiver Collar off and lead him back into the Pet Area.

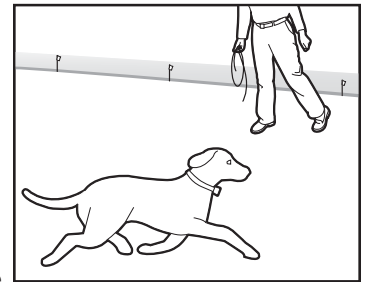

Phase

5

Days 15 thru 30 - Pet Monitoring

Your pet is ready to run! Check in on your pet at regular intervals.

Note: After you are satisfied your pet's training is complete, remove every other Boundary Flag every 4 days until all flags are removed. Save Boundary Flags for future use.

Taking Your Pet Out of the Pet Area

Important: Remove the Receiver Collar and leave it in the Pet Area.

Once your pet learns the Boundary Zone, he will be reluctant to cross it for walks or car rides.

Option 1: Replace the Receiver Collar with a regular collar. Put your pet in a car that is within the Pet Area and drive him out of the Pet Area.

Option 2: Replace the Receiver Collar with a regular collar and leash. Walk your pet out of the Pet Area while giving a command such as "OK" at a specific place of the Boundary Zone (the end of your driveway, sidewalk, etc.). Always leave the Pet Area with a leash at this place and your pet will associate leaving the Pet Area only on a leash, only at this place, and only with a person. You may initially need to convince your pet to leave the Pet Area with a food treat and lots of praise.

Note: You may also carry your pet out of the Pet Area.

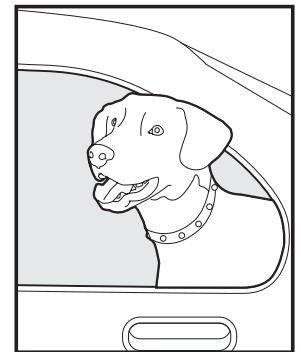

Congratulations! You have now successfully completed the training program.

Working with PetSafe® Pawz Away® Pet Barriers

Your YardMax™ Receiver Collar also works with our Pawz Away® deterrence products to keep your pet away from areas inside or outside your home.

The Pawz Away® Mini Pet Barrier (part number PWF00-14040) transmits an elliptical radio signal adjustable up to 5 feet. Pinpoint off limit areas for pets indoors or outdoors with this discreet battery operated, waterproof barrier (13A).

The Pawz Away® Indoor Pet Barrier (part number ZND-1000) protects many areas inside your home and can teach your pet to stay off of furniture, away from trash or out of certain rooms. The small, battery operated Indoor Barrier fits discreetly inside your home and protects a circular area up to 12 feet in diameter (13B).

The Pawz Away® Outdoor Pet Barrier (part number RFA-378) teaches your pet to avoid areas in your landscape. The waterproof and battery operated Outdoor Barrier is disguised as a rock to blend into your landscape. It can wirelessly protect a circular area up to 16 feet in diameter or protect a custom shaped area using up to 150 feet of Boundary Wire (13C).

The Pawz Away® Pet Barriers are easy to operate and you can use more than one to protect multiple areas. Purchase the Pawz Away® Pet Barriers by visiting our website at www.petsafe.net or by calling the Customer Care Center.

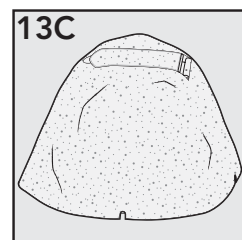
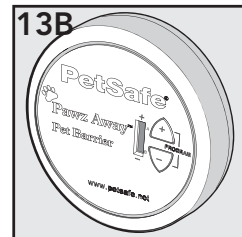
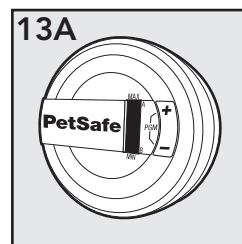

Accessories

To purchase additional accessories for your PetSafe® YardMax™ Rechargeable In-Ground Fence™, contact the Customer Care Center or visit our website at www.petsafe.net to locate a retailer near you.

Component	Part Number
Power Adapter for the Fence Transmitter	RFA-373
Surge Protection Kit	LP-4100-1
Replacement Collar Strap	RFA-509
Additional YardMax™ Receiver Collar	PIG00-11116
Additional Boundary Wire	RFA-1
Additional Boundary Flags	RFA-2
Additional Gel-filled Capsules and Wire Nuts	RFA-366
Wire & Flag Accessory Kit	PIG00-13769
Fence Transmitter	RFA-231
Wire Break Locator	RFA-450
Receiver Collar Charger	PIF00-13981
Contact Point Accessory Pack	PIG00-14222

Additional Information

- Use care when using a weed eater or when digging near the Boundary Wire to prevent damage.
- The system should only be used with healthy pets. Contact your veterinarian if you have concerns about the medical condition of your pet (medication, pregnant, heart conditions, etc.).
- The PetSafe® YardMax™ Rechargeable In-Ground Fence™ is for residential use only.
- The Static Correction will get your pet's attention, but will not cause harm. It is designed to startle, not to punish.
- Remove the Receiver Collar from your pet when indoors for the comfort of your pet.
- Never leave the Receiver Collar on your pet for more than 12 consecutive hours.

Frequently Asked Questions

Is the Receiver Collar waterproof?	<ul style="list-style-type: none"> • Yes.
What happens if the power goes out?	<ul style="list-style-type: none"> • Your pet will no longer be contained. Be sure to contain by another means.
If my pet leaves the Pet Area, how long will he be corrected?	<ul style="list-style-type: none"> • Your pet will receive Static Correction for up to 15 seconds as long as he is outside the Pet Area.
How often do I need to charge the Receiver Collar battery?	<ul style="list-style-type: none"> • Each charge can last up to 3 months depending upon frequency of use. The Receiver Indicator Light acts as a low battery indicator, flashing red every 4 seconds when battery charging is required.
Can I place the Receiver on another collar?	<ul style="list-style-type: none"> • Yes. You may use any 3/4 inch, non-metallic collar.
What do I do if my pet's neck becomes red and irritated?	<ul style="list-style-type: none"> • This condition is due to the Contact Points irritating the skin. Discontinue use of the Receiver Collar for a few days. If the condition persists beyond 48 hours, see your veterinarian. Once the skin returns to normal, replace the Receiver Collar and monitor the skin condition closely.
Can I attach a leash to the Receiver Collar?	<ul style="list-style-type: none"> • No. This can result in pulling the Contact Points too tightly against your pet's neck or the collar may break. Attach a leash to a separate, non-metallic collar positioned above the Receiver Collar.
Why does my Receiver Collar have a tone only mode?	<ul style="list-style-type: none"> • The tone only mode can be used in training your pet to his boundary or for well-trained pets that no longer require Static Correction.

Troubleshooting

Receiver Collar is not beeping or correcting.	<ul style="list-style-type: none"> • Make sure Static Correction is set at 2 or above. • Charge the Receiver Collar and go through the ReadyTest® and PerfectFit™ diagnostic tests. • Check that the Fence Transmitter Power is turned ON and the transmitter status light is solid green. If not, perform the "System Test" (page 27). • In YardMax™ mode, excessive snowfall (>1.5 feet) may place your dog outside the signal field. You may need to switch to Traditional Mode or increase the boundary width until the snow recedes.
The Receiver Collar is beeping, but the pet is not responding to the Static Correction.	<ul style="list-style-type: none"> • Make sure Receiver Collar is turned on, and Battery Status Lights are flashing every 4 seconds. • Test the Receiver Collar with the Test Light walking over the Boundary Wire. • If the Test Light flashes, check the fit of the Receiver Collar using the PerfectFit™ feature. • Trim your pet's fur where the Contact Points touch the neck or use the long Contact Points. • Increase the Static Correction Level. • Repeat training steps to reinforce training.
In YardMax mode, the Receiver Collar corrects when the pet returns to the Pet Area.	<ul style="list-style-type: none"> • Check the YardMax Fence Mode (A/B) Switch is set to A. • Reverse the wires connected to the Fence Transmitter. Leave surge protector alone. • Re-test the boundary.
The Receiver Collar has to be held on top of the Boundary Wire to activate.	<ul style="list-style-type: none"> • Charge the Receiver Collar. • (Traditional Mode only) Adjust Boundary Width Dial clockwise to increase the distance from the Boundary Wire that the Receiver Collar activates. Recommended distance is 10' from Boundary Wire. • If using a Double Loop, make sure Boundary Wires are separated by at least 5 feet. • If the Receiver Collar still has to be held on top of the Boundary Wire, perform the "System Test" (page 27).
The Receiver Collar activates inside the house.	<ul style="list-style-type: none"> • Make sure the Boundary Wire is not running within 15 feet of the house. The signal can transmit through the walls of your house. • Make sure Boundary Wires are twisted from Boundary to the Fence Transmitter. • (Traditional Mode only) Turn the Boundary Width Dial to decrease the distance from the Boundary Wire that the Receiver Collar activates.

<p>I have an inconsistent signal.</p>	<ul style="list-style-type: none"> • Make sure Fence Transmitter is at least 3 feet from large metal objects or appliances. • Make sure all Boundary Wire turns are gradual. • Make sure the Boundary Wire is not running parallel to and within 10 feet of electrical wires, neighboring containment systems, telephone wires, television or antenna cables, or satellite dishes. • If a neighboring containment system may be causing an inconsistent signal, move the Boundary Wire farther away from the neighboring containment system.
<p>Transmitter status light and alarm indicates Boundary Wire is broken or disconnected.</p>	<ul style="list-style-type: none"> • Check Boundary Wire connections at the Fence Transmitter and/or Surge Protector for proper connection. • Check for broken or damaged Boundary Wires at outside entry to the house. • Perform "System Test" (page 27). • Perform "Wire Break Location Test" (page 28).
<p>No status light on the Fence Transmitter and alarm is silent.</p>	<ul style="list-style-type: none"> • Verify the transmitter power is ON. • Check that the Power Adapter and/or Surge Protector are plugged in properly. • If the system is plugged into a GFCI outlet, check to see if the circuit has been tripped. Reset GFCI circuit if required. • Verify that the outlet is working properly by plugging in a known working item such as a radio. • If a Surge Protector is installed, unplug the Surge Protector and plug the Power Adapter directly into the outlet. If the transmitter operates without the Surge Protector, contact the Customer Care Center for a replacement Surge Protector.
<p>Receiver Collar is not charging.</p>	<ul style="list-style-type: none"> • Check that the charger is properly seated into the Receiver Collar Jack. • If the Indicator Light on the Receiver Collar still does not glow red when connected to charger, there is a problem with the charger. If the Indicator Light glows red when placed on the charger but goes out after disconnecting the Receiver Collar without performing the ReadyTest® there is a problem with the Receiver Collar. Call the Customer Care Center.
<p>In YardMax Mode, my dog is able to cross the Boundary Wire in either direction without receiving a Static Correction.</p>	<ul style="list-style-type: none"> • Make sure the Fence Transmitter is set to YardMax Fence Mode A • Starting inside the Pet Area, when crossing the Boundary Wire, the Receiver Collar should tone at a distance of 1 ½ feet above the dog's neck height (Step 8 page 16).
<p>In YardMax mode, the Receiver Collar corrects within the Pet Area.</p>	<ul style="list-style-type: none"> • Check and make sure that the receiver activation height is not greater than 1 ½ feet above the dog's neck height (Step 8 page 16) when crossing the Boundary Wire. • There could be an inconsistent signal due to close proximity to telephone wires or television cables etc. Readjust boundary wires where crossing buried cables as instructed (Step 5 page 13).
<p>My pet reacts strongly to the Static Correction and has become fearful.</p>	<ul style="list-style-type: none"> • Lower the Static Correction Level. • Make sure you are in control of the situation when your pet receives his first Static Corrections (have him on a leash attached to a separate, non-metallic collar) and lead him into the Pet Area and praise him. If your pet remains fearful, suspend training and start again the next day. Make sure to end all training sessions on a positive note with lots of praise and play.
<p>The Receiver Collar has injured my pet's neck.</p>	<ul style="list-style-type: none"> • Failing to follow the important safety information at the front of the Operating and Training Guide has caused pressure ulcers. Some descriptions of advanced pressure ulcers describe the sores as looking like burns on the dog's neck. Be assured that electronic collars do not use enough energy to create electrical burns. The energy in an output pulse is only a few thousandths of a Joule; it is similar in nature to the static pulse that you may feel when getting out of your car. In some cases, pressure ulcers are described as chemical burns. The battery in your Receiver Collar is sealed, in addition, your collar's housing is also sealed. This redundant sealing makes it virtually impossible, without misuse or abuse, for your Receiver Collar battery to leak onto your pet's neck. Please review and follow the important safety information on page 5, and the instructions in Step 11 under the heading "Fit the Receiver Collar" on pages 17 and 18.

System Test

The system test is used to determine the cause of system problems that have not been addressed elsewhere in this guide. You will need a piece of Boundary Wire greater than 15 feet long with $\frac{3}{8}$ inch of insulation removed from each end to use as a test loop wire. Make a note of your Boundary Width Dial setting, and Receiver Collar setting before beginning the System Test. Follow the steps below to perform the system test:

1. Remove the Receiver Collar from your dog and make sure it is fully charged.
2. Set the Receiver Collar Static Correction Level to 6.
3. Disconnect the twisted Boundary Wire from the Boundary Wire terminals on the Fence Transmitter by pressing the red release levers on the connector and pulling the wires free (14A).
4. Insert the two ends of the test loop wire into the Boundary Wire Terminals on the Transmitter.
5. Set Transmitter to Mode B, Traditional Mode, and turn it ON.
6. Turn the Boundary Width Dial to 5.
7. Place the Test Light Tool Contacts on the Contact Points of the Receiver Collar. While holding the Receiver Collar with the Test Light Tool in place, approach the wire from the outside loop 2 inches off the ground. Make a mental note of the distance where the Receiver Collar activates from the wire.
8. Turn the Boundary Width Dial to 10 and repeat Step 7. The distance where the Receiver Collar activates should be greater than the previous result.
9. If more than one Receiver Collar is used on the system, repeat the above test on each collar.
10. Interpreting the Results:
 - a. If the Power light or the Loop indicator light are not both lit on the Fence Transmitter, or the alarm is on, for any of the above tests, there is a problem with the Transmitter. Contact the Customer Care Center.
 - b. If both the Power and Loop indicator lights are on, but the Receiver Collar does not activate on the test loop wire, the Receiver Collar is not working. Contact the Customer Care Center.
 - c. If the Transmitter Power and Loop indicator lights are on and the Receiver Collar is activating at different distances on the test loop wire, the problem is most likely in the containment Boundary Wire or Surge Protector. Reconnect the Transmitter wires to the Surge Protector and connect the Test Loop to the Surge Protector loop terminals. Repeat steps 6-9 (14B).
11. Interpreting the Results with the Surge Protector:
 - a. If both the Power and Loop indicator lights are ON and the Receiver Collar is activating at different distances on the test loop wire, the problem is in the containment Boundary Wire. Perform the Wire Break Location Test.
 - b. If the Loop indicator light is OFF with an alarm on the Fence Transmitter, there is a problem with the Surge Protector. Contact the Customer Care Center.
12. When testing is complete reconnect and verify that the Boundary Wire is plugged into the Loop Terminals on the Surge Protector and the Transmitter is connected to the Surge Protector.
13. Return the Boundary Width Dial and Receiver Collar settings to the position noted earlier.
14. Set Transmitter Mode Switch to your original setting YardMax™ (Mode A) or Traditional Made (Mode B).
15. Repeat testing for Steps 8A for YardMax™ (page 16) or 8B for Traditional Mode (page 17).

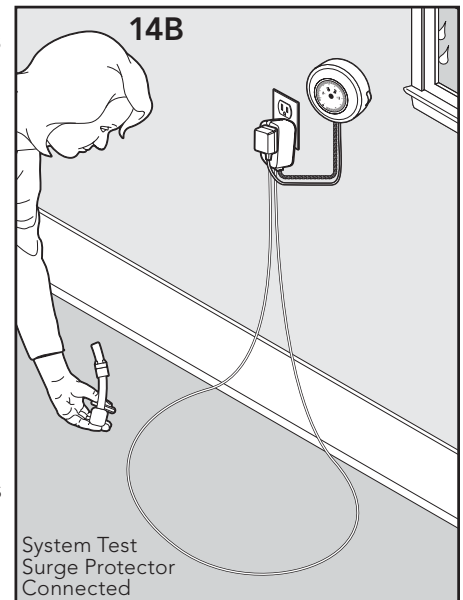
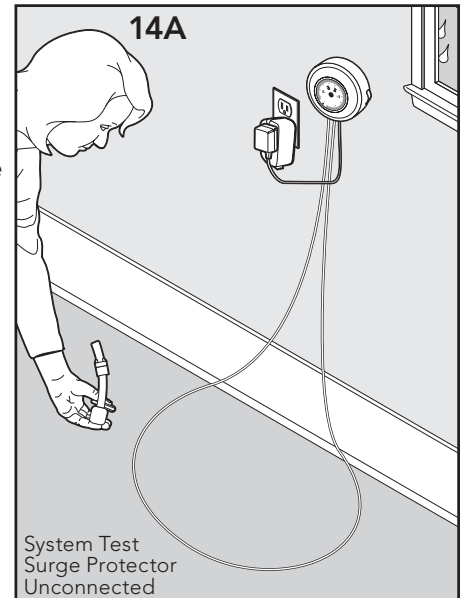

Wire Break Location Test

The following lists identify the common locations where wire breaks occur. Please inspect these areas for signs of damage.

Wire breaks in the twisted pair are commonly found:

1. At the wire exit point of the house
2. Where the twisted pair of wire enters the ground from the house, usually caused by string trimmers
3. Where the wires cross sidewalks or driveways due to edging and string trimmers
4. Around landscaping and flower beds due to digging, or working up the soil

Wire breaks in the Boundary Wire are commonly found:

1. In aerated lawns
2. Where the wires cross sidewalks or driveways due to edging and string trimmers
3. Around landscaping and flower beds due to digging, or working up the soil
4. At wire splices where Gel-filled capsules have not been installed
5. At wire splices without reinforcement knots (refer to Figure 5E)

If you still cannot find the break in the Boundary Wire, there are two options for locating it:

Option 1: It is recommended to contact the Customer Care Center to purchase a Wire Break Locator (RFA-450).

Option 2: Follow the procedure below:

1. Unplug the Fence Transmitter.
2. Connect both ends of your twisted Boundary Wire to one Loop Terminal on the Surge Protector.
3. Measure and cut a Test Wire which is half the length of your total Boundary Wire footage.
4. Connect one end of Test Wire to the other Loop Terminal on the Surge Protector.
5. Locate the halfway point of your boundary and cut the Boundary Wire.
6. Splice the other end of the Test Wire to either side of your Boundary Wire where you cut it in half.
7. Plug in the Fence Transmitter slide to Mode B, Traditional Mode, and check the Loop Indicator Light. If the Loop Indicator Light is ON, you can assume the break is in the other half of the Boundary Wire.
8. If the Loop Indicator Light did not come on, you may assume there is a break in this portion of the Boundary Wire. However, there is a small chance of having more than one break in your system. Be sure to check both halves of your entire loop.
9. Replace the damaged Boundary Wire with new Boundary Wire.
10. Reconnect the Boundary Wire to the Surge Protector.
11. Check the Loop Indicator Light. If the Loop Indicator Light is ON, test the system with the Receiver Collar.

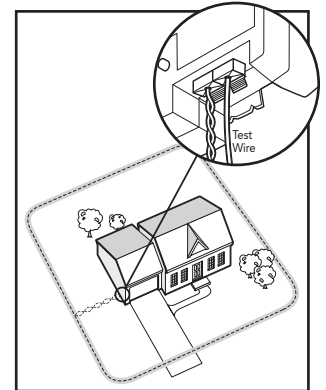

Terms of Use and Limitation of Liability

1. Terms of Use

This Product is offered to you conditioned upon your acceptance without modification of the terms, conditions and notices contained herein. Usage of this Product implies acceptance of all such terms, conditions, and notices.

2. Proper Use

This Product is designed for use with pets where training is desired. The specific temperament of your pet may not work with this Product. We recommend that you not use this Product if your pet is less than 5 pounds or if your pet is aggressive. If you are unsure whether this is appropriate for your pet, please consult your veterinarian or certified trainer.

Proper use includes reviewing the entire Guide provided with your Product and any specific Caution statements.

3. No Unlawful or Prohibited Use

This Product is designed for use with pets only. This pet training device is not intended to harm, injure or provoke. Using this Product in a way that is not intended could result in violation of Federal, State or local laws.

4. Limitation of Liability

In no event shall Radio Systems Corporation® be liable for any direct, indirect, punitive, incidental, special or consequential damages, or any damages whatsoever arising out of or connected with the use or misuse of this Product. Buyer assumes all risks and liability from the use of this Product.

5. Modification of Terms and Conditions

Radio Systems Corporation® reserves the right to change the terms, conditions and notices under which this Product is offered.

Compliance

FCC/Canada

This Class B digital apparatus complies with Canadian ICES-003. This equipment has been tested and found to comply with the limits for a Class B digital device, pursuant to Part 15 of the FCC Rules. These limits are designed to provide reasonable protection against harmful interference when the equipment is operated in a residential environment. This equipment generates, uses, and can radiate radio frequency energy and, if not installed and used in accordance with the instruction guide, may cause harmful interference to radio communications. However, there is no guarantee that interference will not occur in a practical installation. If this equipment causes harmful interference to radio or television reception, which can be determined by turning the equipment off and on, the user is encouraged to try to correct the interference by one or more of the following measures:

- Relocate the interfered receiving antenna.
- Increase the separation between the equipment and receiver.
- Connect the equipment into an outlet on a circuit different to that to which the receiver is connected.
- Contact the Customer Care Center.

This device complies with Industry Canada Rules. This device complies with part 15 of the FCC Rules. Operation is subject to the following two conditions: (1) This device may not cause harmful interference, and (2) this device must accept any interference received, including interference that may cause undesired operation.

Unauthorized changes or modifications to the equipment, not approved by Radio Systems Corporation®, could result in not meeting compliance with FCC regulations and could void the user's authority to operate the equipment.

Australia

This device complies with the applicable EMC requirements specified by the ACMA (Australian Communications and Media Authority).

Customer Care International

Canada - Tel: 800-732-2677

Monday - Friday 8 AM - 8 PM / Saturday 9 AM – 5 PM

Australia - Tel: 1800 786 608

Monday - Friday 8:30 AM - 5 PM

New Zealand - Tel: 0800 543 054

Monday - Friday 10:30 AM - 7 PM

This product has the benefit of a limited manufacturer's warranty. Details of the warranty applicable to this product and its terms can be found at www.petsafe.net and/or are available by sending a stamped addressed envelope to PetSafe® Ltd. Redthorn House, Unit 9, Chorley West Business Park, Ackhurst Road, Chorley, Lancashire PR7 1NL, United Kingdom.

Warranty

One Year Non-Transferrable Limited Warranty

This Product has the benefit of a limited manufacturer's warranty. Complete details of the warranty applicable to this Product and its terms can be found at www.petsafe.net.

Australia/New Zealand - In compliance with the Australian Consumer Law, Warranties Against Defects, effective January 1, 2012, warranty details of this Product are as follows:

One Year Non-Transferrable Limited Warranty

What is covered: Radio Systems Australia Pty Ltd (hereinafter referred to as "Radio Systems") warrants to the original retail purchaser, and not any other purchaser or subsequent owner, that its Product, when subject to normal and proper residential use, will be free from defects in material or workmanship for a period of one (1) year from the purchase date. An "original retail consumer purchaser" is a person or entity who originally purchases the Product, or a gift recipient of a new Product that is unopened and in its original packaging. When serviced by Radio Systems Customer Service, Radio Systems covers labor and parts for the first year of ownership; after the first year, a service or upgrade charge will apply relative to replacement of the Product with new or refurbished items at Radio System's sole discretion.

The limited warranty is non-transferrable and shall automatically terminate if the original retail consumer purchaser resells the Radio Systems Product or transfers the property on which the Radio Systems Product is installed. This Limited Warranty excludes accidental damage due to dog chews; lightning damage; or neglect, alteration, and misuse. Consumers who **purchase Products outside of Australia, New Zealand, or from an unauthorized dealer will need to return the Product to the original place of purchase for any warranty issues.**

Please note that Radio Systems does not provide refunds, replacements, or upgrades for change of mind, or for any other **reason outside of these Warranty terms.**

Layout Grid

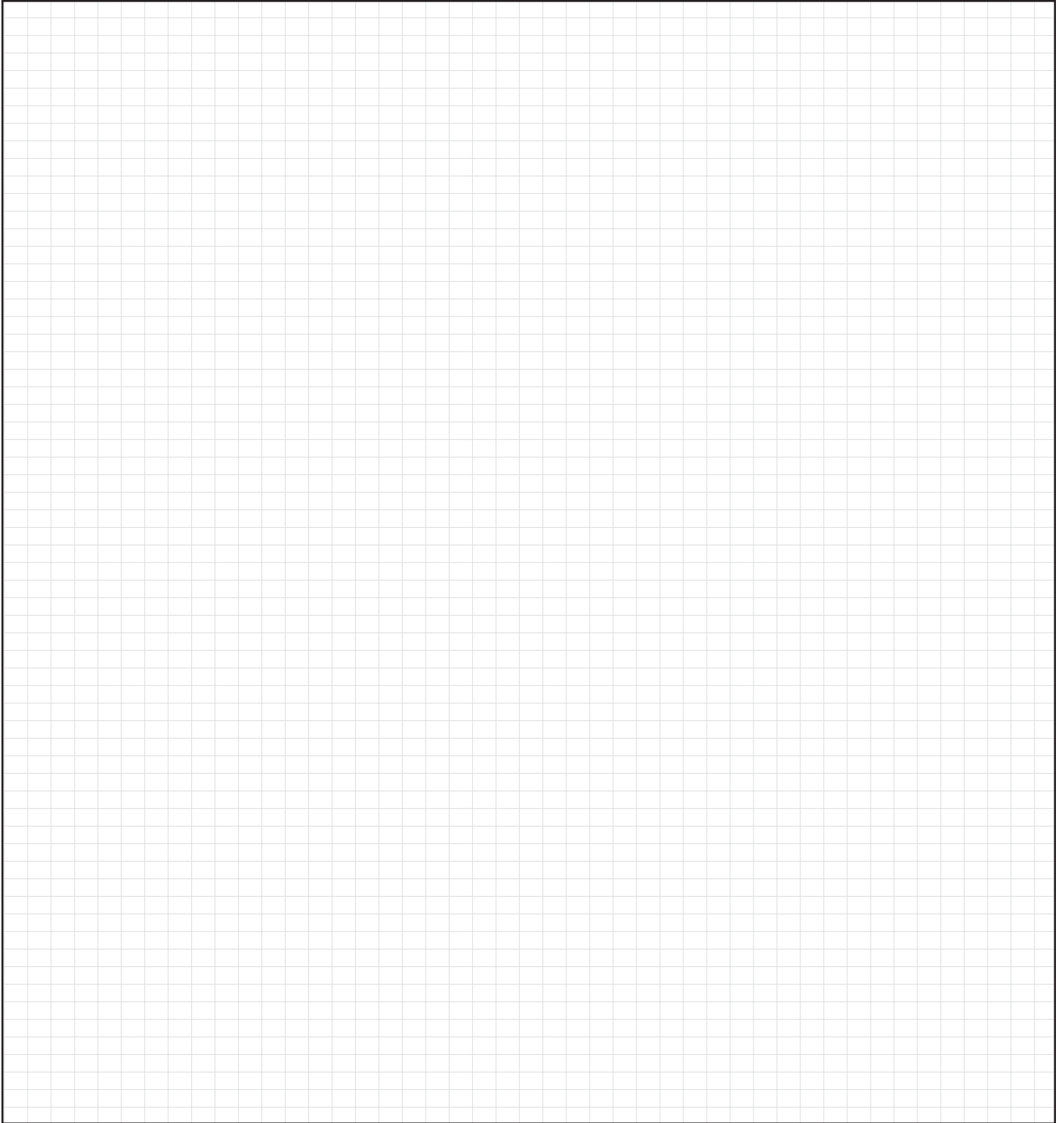

Radio Systems® Corporation
10427 PetSafe Way
Knoxville, TN 37932
1-800-732-2677
www.petsafe.net

Protected by US Patents 6,184,790; 6,327,999; 6,459,378; 6,807,720; 7,046,152; 7,068,174; 7,117,822;
7,204,204; 7,278,376; 7,345,588; 7,394,390; 7,495,570; 8,047,161; and 8,342,135.
400-002/1